

Heterogeneous Integration on Si Platform: Emerging Nanoelectronics for 'More-than-Moore' and 'Beyond CMOS' Approaches



by Engr. Assoc. Prof. Dr Abdul Manaf Hashim,
Engr. Shaharin Fadzi Abd. Rahman and
Engr. Mastura Shafiqah Zainal Abidin

IN line with the evolution of Si nanoelectronics, fundamental researches on emerging materials and novel processes and devices which could contribute towards future 'smart electronics' and 'green electronics' are aggressively being carried out worldwide. Specifically, this article provides a brief overview on the recent trend of electronics and introduces an outline of the author's research projects on graphene, germanium and III-V semiconductor. The work has been carried out with the collaboration of Hokkaido University, Kyushu University, Universiti Sains Malaysia and Universiti Teknologi MARA. These projects have been mainly funded by MOHE, MOSTI, UTM, MJIIT and the Hitachi Foundation.

The performance of silicon-large scale integrated circuits (Si-LSIs) has been enhanced over the last 30 years by increasing the number of transistors in accordance with Moore's law. The number of transistors in the latest processor has already exceeded 1 billion [1]. The scaling rule of the Si transistor has made it possible to enhance the performance of the LSIs. However, the miniaturisation of the transistors has become increasingly difficult owing to physical limitations, while the conventional scaling rule is insufficient to enhance the performance of the LSIs. Therefore, some breakthrough technologies are strongly required for the Si-LSIs in order to enhance the performance of the device, even in the post-scaling era.

The most promising breakthrough in technology are the new semiconductor materials with higher mobility than Si, which could increase the driving current of MOS transistors. Graphene, germanium (Ge) and III-V materials are some of the most promising candidates for new channel materials [Figure 1]. These materials are also expected to give high carrier injection velocity at the source terminal owing to their low effective mass and low carrier scattering, which lead to the increase in the efficiency of ballistic transport [2].

Ideally, those materials would need to be realised on the Si platform, meaning that they should be grown on large-area Si wafers by methods compatible with standard Si CMOS fabrication technology and also the Si CMOS LSI design environment. For example, since III-V has a higher electron mobility and Ge has a higher hole mobility than Si, those materials can be used for conventional n-MOS and p-MOS, respectively [3]. Hence, the present Moore's Law (More Moore) can be further extended [Figure 1]. Those

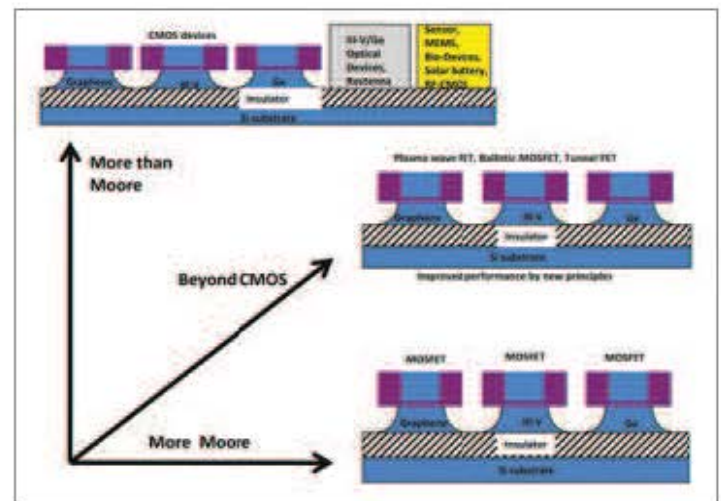

Figure 1: Concepts of 'More Moore', 'More-than-Moore' and 'Beyond CMOS'

materials (Graphene, Ge, III-V) grown on insulator on Si can not only be used to fabricate conventional metal-oxide-semiconductor field-effect transistors (MOSFETs), but also other type of MOSFET devices with different switching principles, such as plasma wave FETs [4,5], tunnel FETs [6] and spin FETs [7]. This direction will lead to the 'Beyond CMOS' technology [Figure 1].

In addition, those materials on insulator on Si can also be used to fabricate other functional devices, such as optical devices [8], photodetectors [9] and solar batteries [10], to be integrated with conventional Si CMOS to realise new smart LSI chips such as intelligent system-on-chip on silicon. This direction will lead to the More than Moore technology [Figure 1]. As a result, by integrating such devices on a Si CMOS platform, the capability, functionality and also the value of the device system could be increased. As a next-generation technology, such advanced heterogeneous integration on the Si platform is considered as a promising and practical direction [11].

FUNDAMENTAL WORK ON GRAPHENE NANOMATERIALS AND NANODEVICES

In recent years, graphene has attracted enormous attention as a possible substitute of silicon as a channel in CMOS technology due to its attractive and superior characteristics. Furthermore, graphene-based devices can also support the

recent trend of technology towards the so-called "green electronics" due to its non-toxic element and low power consumption. Graphene is a zero band gap semiconductor and carriers in the graphene behave as massless Dirac fermions having ultra-high electron mobility up to 200,000 cm²/Vs at room temperature [12]. Owing to its superiority, graphene offers the possibility of the novel electronic device operating with ballistic transport, which occurs when the length of electron channel is shorter than the mean free path of the electron. Graphene also exhibits a unique ambipolar transport characteristic, where the conduction type of graphene can be tuned by applying suitable gate voltage [13].

In order to utilise and understand the potential of graphene, we have successfully conducted research on several physical key issues and on a graphene-based nanodevice, known as a three-branch nanojunction (TBJ) device [Figure 2] [14]. A clear non-linear characteristic of the graphene-based three-branch nanojunction device having high mobility at room temperature was demonstrated. Based on these successful findings, it is concluded that graphene is a potential new channel material for future electronic devices and our proposed TBJ device is a promising novel device that could replace the conventional CMOS.

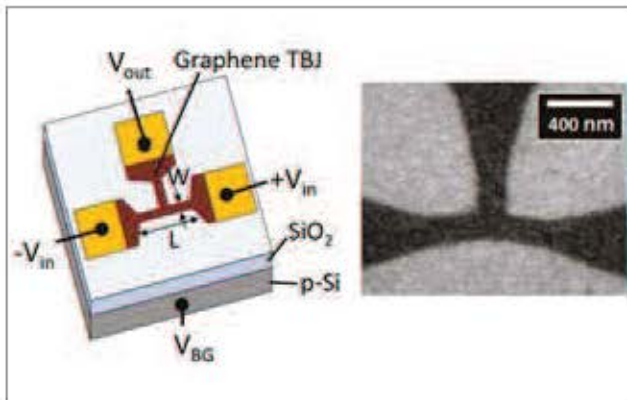

Figure 2: Fabricated three-branch-junction device

GROWTH OF GERMANIUM-ON-INSULATOR ON SILICON

High quality Ge layers on insulators (GOI) on silicon are promising materials to surpass the performance of the current silicon transistors since the mobility of electrons in germanium is two times greater, and the mobility of holes is 4 times greater than that in silicon [6]. Moreover, GOI structures are also important as channel materials of spin-transistors and virtual substrates of direct-bandgap materials with optical functions to create multifunctional 3D-LSIs. The high-quality orientation-controlled GOI structures are essential to realise such high-performance electronic and sensing devices and also to act as an epitaxial template for multifunctional 3D-LSIs.

In this work, we utilise the Si-seeded rapid-melting growth technique [15]. Here, the Si substrate is used as a seed to induce the lateral growth of Ge, since there is a

spatial gradient of the solidification temperature originating as a result of the Si-Ge mixing in the seeding area [Figure 3]. Thus far, our study shows that the growth of defect-free single-crystalline Ge stripes ($\leq 5 \mu\text{m}$ width and μm 0.5 spacing) with a capping layer on the top can be achieved. These preliminary results provide a breakthrough towards the realisation of heterogeneous integration on Si platforms with multi-functionalities.

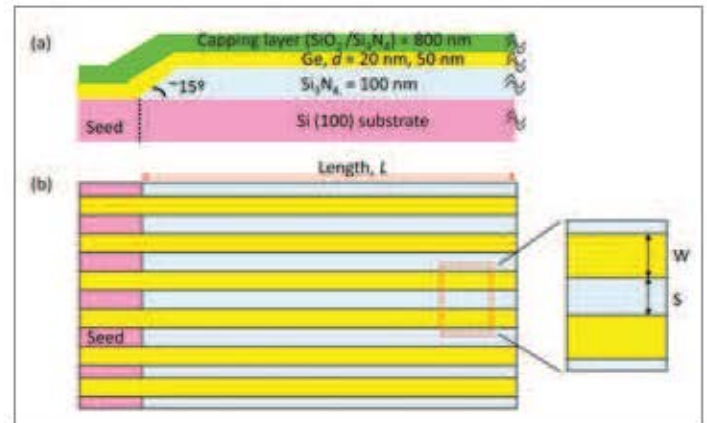

Figure 3: Schematic of fabricated stripe-array GOI structure (a) cross-sectional view and (b) top view. W: width, S: spacing

DEMONSTRATIONS OF SEVERAL KINDS OF FUNCTIONAL DEVICES ON III-V BASED MATERIALS (GAAS, GAN) TOWARDS 'MORE THAN MOORE' AND 'BEYOND CMOS'

III-V compound materials, in general, have a significantly higher intrinsic (p or n) mobility compared to silicon; thus they have the potential for enabling future high-speed transistors for digital applications at a very low supply of voltages. III-V compound semiconductors have been used in commercial communication and optoelectronic products for a long time. For III-V compound semiconductors to become applicable for future high-speed and low-power digital applications, they will need to be integrated onto large silicon wafers [11]. A seamless, robust heterogeneous integration scheme of III-V on silicon will allow high-speed, low-voltage III-V based transistors to couple with the mainstream Si CMOS platform, while avoiding the need for developing large diameter ($\approx 300\text{mm}$) III-V substrates.

Besides transistor applications, successful integration of III-V materials on silicon also creates opportunities for integrating new functionalities and features on silicon, such as integrating logic, optoelectronic, and communication platforms on the same silicon wafer. However, heterogeneous integration of III-V on silicon imposes many significant technical challenges because of the large lattice mismatch between the two materials. It is noted here that presently, we do not focus on the growth of III-V on Si. Instead, we are focusing on the studies which intend to show the feasibility of applying those III-V materials for several kinds of functional devices such as three-branch-junction devices, sensing devices and detectors to be integrated on the Si platform.

(i) Logic Gates Based on Schottky Gate-Controlled Three-Branch GaAs Nanowire Junctions

As Si CMOS technology had come to its scaling limit, a search for new nano-structured material such as semiconductor nanowire becomes significant to be integrated on Si platform. By utilising the unique features and structure of nanowire, a novel functional nanodevice is expected. One of the emerging devices utilising nanowire is the three-branch nanowire junction (TBJ) device [16]. In this project, a GaAs-based TBJ with Schottky wrap gates (WPGs) was investigated to realise novel Boolean logic gates [Figure 4]. It was confirmed that the WPG-controlled TBJ showed a bell-shaped voltage input-output curve and was controlled by gate voltage on the WPGs. The correct operations of AND gate, NOT gate and NAND gate have been confirmed.

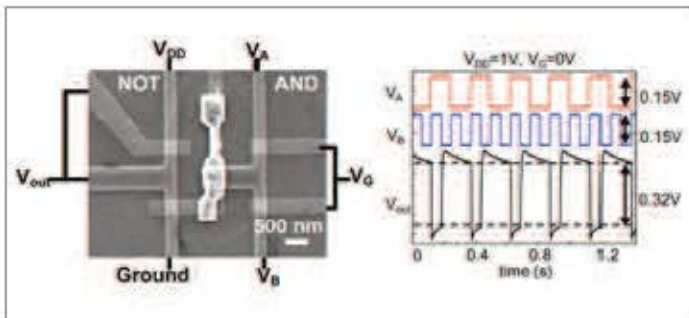

Figure 4: NAND gate fabricated by integrating two WPG-controlled TBJs and correct operation with a voltage transfer gain of 2.2

(ii) III-V Semiconductor Based Integrated On-Chip HEMT Devices for RF Power Detector in Nanosystems

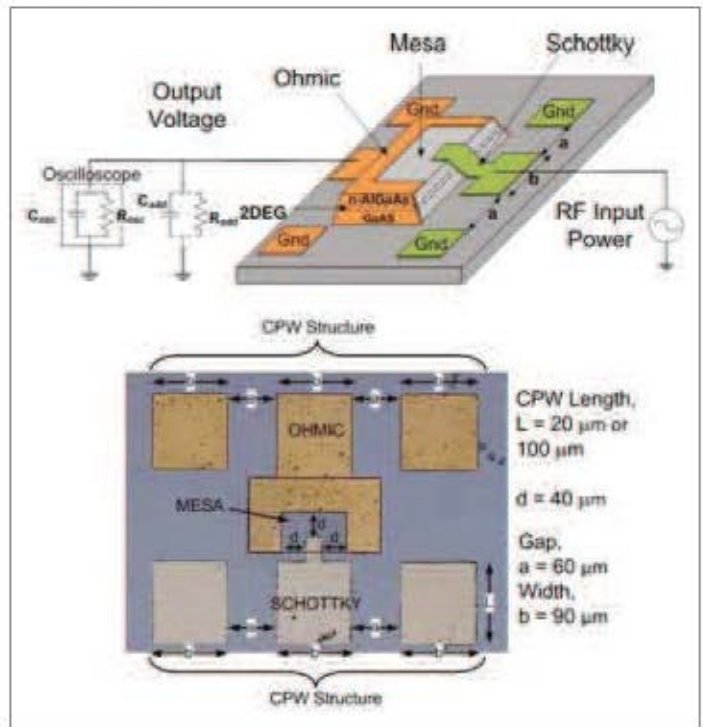

Figure 5: On-chip Schottky diode for RF power detector

Explosive growth of internets and wireless technologies has opened up prospects towards an advanced ubiquitous

network society where nanoelectronic devices are the most promising option for such technologies. Therefore, those nanoelectronic systems are increasingly vulnerable to malfunction due to incident electromagnetic radiation, particularly since many integrated circuits operate at lower and lower voltages. Then, it becomes a great interest to know how, and at what level, microwaves penetrate equipment shielding and reach the vulnerable chips. Schottky diode was designed and fabricated on n-AlGaAs/GaAs high-electron-mobility-transistor structure for RF power detection [Figure 5] [17-19]. The fabricated Schottky diodes detected RF signals well and their cut-off frequencies up to 20 GHz were estimated in direct injection experiments. These preliminary results provide a breakthrough for the direct on-chip integration technology towards realisation of heterogeneous integration on the Si platform.

(ii) III-V Semiconductor Based Liquid Phase Sensor for Selective Ion Sensing Application

Many semiconductor materials have been tested for their suitability as ion sensors; especially there is an emerging interest in the use of wide band gap semiconductors as sensitive chemical sensors. AlGaN/GaN high-electron-mobility-transistor (HEMT) structures have been extremely useful for gas and liquid-phase sensors due to their excellent properties. Sensing responses of an open-gate liquid-phase sensor fabricated on undoped-AlGaN/GaN high-electron-mobility-transistor (HEMT) structure have been investigated in aqueous solution [Figure 6] [20, 21]. The open-gate undoped AlGaN/GaN HEMT structure is capable of distinguishing pH level in aqueous electrolytes and exhibits linear sensitivity, where the high sensitivity of 1.9 mA/pH or 3.88 mA/mm²/pH was obtained. The fabricated open-gate undoped-AlGaN/GaN structure is expected to be suitable for pH sensing application.

sensors are strongly demanded to avoid hazardous explosion. High temperature operation and long term stability are important requirements for a gas sensor. GaN based materials are known as wide-bandgap semiconductors that show great promise for electronic devices operating at high temperatures. The response of Pt-circular Schottky diodes fabricated on undoped AlGaN/GaN high-electron-mobility-transistor (HEMT) structure to hydrogen gas at various temperatures, ranging from 25°C to 200°C has been investigated [Figure 7] [22, 23]. Both forward and reverse currents of the device increase when they are exposed to hydrogen gas. The time-transient characteristics showed the average current increment and decrement speed of 27.6 nA/sec and 17.6 nA/sec, respectively, at a temperature of 200°C. ■

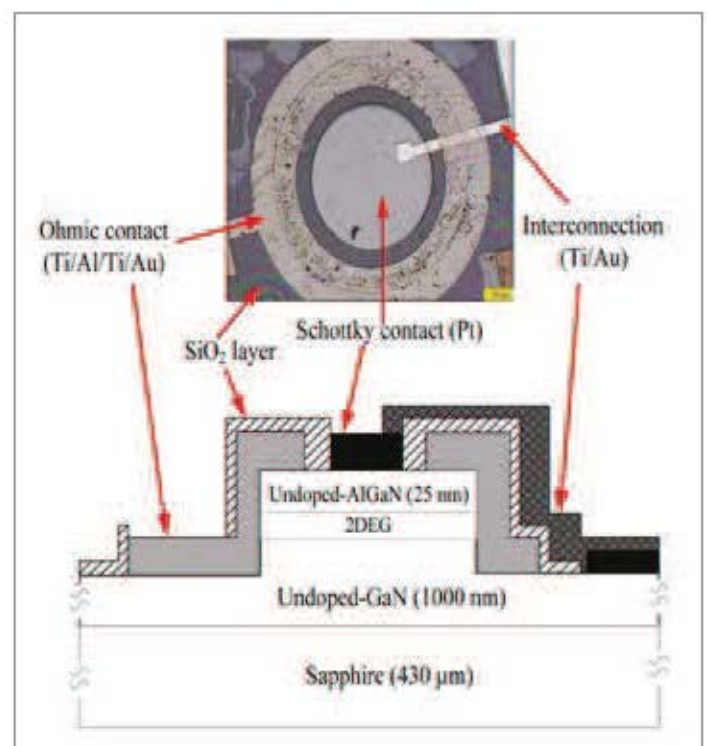

Figure 7: Fabricated gas sensor (Schottky diode)

Engr. Dr Abdul Manaf bin Hashim received his doctorate degree in Electronics and Information Engineering from Hokkaido University, Japan in March 2006. Presently, he is an associate professor at the Malaysia-Japan International Institute of Technology, Universiti Teknologi Malaysia. His research interests include plasma wave devices, sensing devices, quantum nanodevices, thin film and nanostructure growth, and graphene. He has authored and co-authored more than 80 research papers.

Engr. Shaharin Fadzli Abd. Rahman received his M.Eng degree in Electronics for Informatics from Hokkaido University, Japan in March 2009. He joined the Faculty of Electrical Engineering, Universiti Teknologi Malaysia in September 2009. He is currently working toward a PhD degree at Universiti Teknologi Malaysia. His research interests include graphene synthesis, graphene-based nano-devices and compound semiconductor-based devices.

Engr. Mastura Shafinaz Zainal Abidin received her M.Sc degree in Electronics and Telecommunications from Universiti Teknologi Malaysia in March 2010. She joined the Faculty of Electrical Engineering, Universiti Teknologi Malaysia in 2008. Currently, she is pursuing her PhD study at Universiti Teknologi Malaysia. Her research interests include sensing devices, thin film and nanostructure growth.

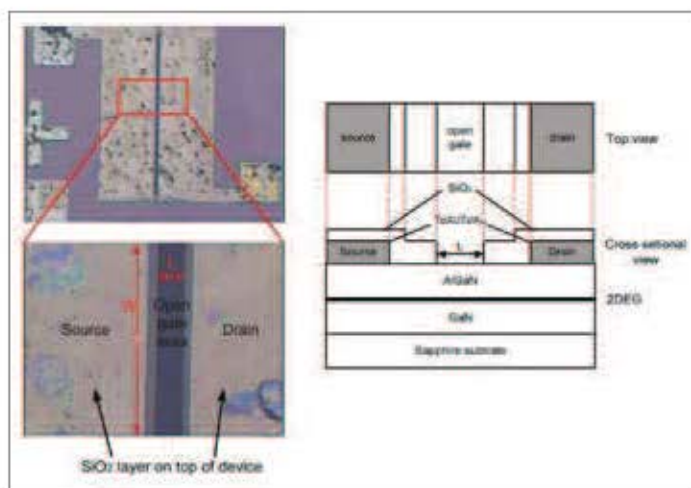

Figure 6: Open-gate liquid-phase sensor fabricated on undoped-AlGaN/GaN high-electron-mobility-transistor (HEMT)

(iv) III-V Semiconductor Based Gas Phase Sensor for High Temperature and Robust Application

In view of increased use of fuel cells as a new clean and viable energy source to replace petroleum, hydrogen

REFERENCES

- [1] R. Pillarisetty: Nature 479 (2011) 324.
- [2] M. Bescond, N. Cavassilas, K. Kalna, K. Nehari, L. Raymond, J.L. Autran, M. Lannoo and A. Asenov: IEDM Tech. Dig. (2005) 526.
- [3] D. Kuzum, T. Krishnamohan, A. Nainani, Y. Sun, P.A. Pianetta, H.S. P. Wong and K.C. Saraswat IEEE Trans. Electron Devices 58 (2011) 59.
- [4] D.B. Veksler, A.V. Muraviev, T.A. Ekhatib, K.N. Salama and M.S. Shur: Proc. Int. Semiconductor Device Research Symp. (2007) 1.
- [5] A.M. Hashim, S. Kasai and H. Hasegawa: Superlattices Microstruct. 44 (2008) 754.
- [6] K. Boucart and A.M. Ionescu: IEEE Trans. Electron Devices 54 (2007) 1725.
- [7] L. En-Shao, N. Junghyo, M.V. Kamran and T. Emanuel: Nano Lett. 10 (2010) 3297.
- [8] S. Itabashi, H. Nishi, T. Tsuchizawa, T. Watanabe, H. Shinjima, S. Park, K. Yamada, Y. Ishikawa and K. Wada: Proc. 7th IEEE Int. Conf. Group IV Photonics (2010) 48.
- [9] J. Wang and S. Lee: Sensors 11 (2011) 696.
- [10] Germanium-Based Technologies – From Materials to Devices, ed. C. Claeys and E. Simoen: Elsevier, Amsterdam, (2007) 406.
- [11] S. Takagi and M. Takenaka: Symp. VLSI Technology (2010) 147.
- [12] K.I. Bolotin, K.J. Sikes, Z. Jiang, M. Klima, G. Fudenberg, J. Hone, P. Kim and H.L. Stormer: Solid State Commun 146 (2008) 351.
- [13] K.S. Novoselov, A.K. Geim, S. V. Morozov, D. Jiang, Y. Zhang, S.V. Dubonos, I.V. Grigorieva and A.A. Firsov: Science 306 (2004) 666.
- [14] S.F.A. Rahman, S. Kasai and A.M. Hashim: Appl. Phys. Lett. 100 (2012) 193116.
- [15] A.M. Hashim, M. Anisuzzaman, S. Muta, T. Sadoh and M. Miyao: Jpn. J. Appl. Phys. 51 (2012) 06FF04.
- [16] S.F.A. Rahman, D. Nakata, Y. Shiratori and S. Kasai: Jpn. J. Appl. Phys. 48 (2009) 06FD01.
- [17] A.M. Hashim, F. Mustafa, S.F.A. Rahman and A.R.A. Rahman: Sensors 11 (2011) 8127.
- [18] F. Mustafa, N. Parimon, A.M. Hashim, S.F.A. Rahman, A.R.A. Rahman and M.N. Osman: Superlattices Microstruct. 47 (2010) 274.
- [19] F. Mustafa, N. Parimon, A.M. Hashim, S.F.A. Rahman, A.R.A. Rahman and M.N. Osman: Microsystem Technol. 16 (2010) 1713.
- [20] M.S.Z. Abidin, Shahjahan and A.M. Hashim: Sains Malaysiana (2012) In Press.
- [21] M.S.Z. Abidin, A.M. Hashim, M.E. Sharifabad, S.F.A. Rahman and T. Sadoh: Sensors 11 (2011) 3067.
- [22] M. Mohamad, F. Mustafa, S.F.A. Rahman, M.S.Z. Abidin, N.K.A. Afiqadi, A.M. Hashim, A.A. Aziz and M.R. Hashim: J. Appl. Sci. 10 (2010) 1797.
- [23] M. Mohamad, F. Mustafa, A.M. Hashim, S.F.A. Rahman, A.A. Aziz and M.R. Hashim: J. Appl. Sci. 10 (2010) 2338.

OBITUARY

With deep regret, we wish to inform that the following members had passed away:

Dato' Ir. Low Kee Yang on 9 November 2012

Ir. Kok Choo Mei on 10 February 2013.

On behalf of the IEM Council and management, we wish to convey our deepest condolences to both families.

The IEM Editorial Board