

# EXPERIMENTAL ROBOTICS SYSTEM IN LABORATORY FOR AGRICULTURE APPLICATION

Ten Seng Teik and Ooi Ho Seng

Mechanization and Automation Centre, MARDI, P.O. Box 12301, GPO, 50774 Kuala Lumpur

Email: stten@mardi.my

## ABSTRACT

*In centuries past, humanity's destiny in agriculture was depended fully on weather, irrigation and soil, but nowadays, with the sophisticated and highly technologies, the ability for humans and machines to cooperate as an integrated team will determine the success to increase and sustain agricultural production in future.*

*The warm, humid and closed conditions in especially in greenhouse are very unfriendly for humans to work in and they are worsened when fertilisers and pesticides are being applied. The infusion of advance technology in mechanisation, automation, environmental controls and in-house mechanisation for crop production in the tropics and sub tropics are important for the development of agriculture and food sectors and is most beneficial to humanity. Malaysia imports agricultural products and processed food worth RM12 billion annually. To experimentally study the locomotion of robot in the laboratory, one has to create a motion environment. In order to study simulations motion of robotics joints, microgravity environments have its best condition to be set up to facilitate the experiments. To set up the microgravity on earth requires some method of compensation for the earth's gravitational field. To accurately produce an earth-based zero gravity condition test-bed is impossible through experimentation. The main objective of this research work is to build a test-bed for robot that operates in the "zero gravity" situation. To achieve this, gravity-less 2 Degrees-Of-Freedom robot with a unique instrumental arrangement will be considered to compensate the gravity force and provide the drag-free and near zero gravity characteristics of space in two dimensions for the robot arms. The robot kinematics and dynamics formulations are studied especially the Newton-Euler formulation. This paper mainly discusses the feedbacks of the robot's arms using mechanical simulation and virtual prototyping software, Mechanical Desktop 4 combined with MSC Working Model as well as the hardware design. These data are very important to verify the formulation or algorithm are correct and suitable in robotics optimum designs. The robotics technology is very important in the future agriculture development especially to substitute man-power since the agriculture and food industry sectors have been identified as the third engine of growth of the national economy, the government had emphasized the need for new approach in agriculture modernisation to help the industry become more productive and competitive in the global economy.*

**Keywords:** Agriculture, Dynamics, Kinematics, Microgravity, Torques

## INTRODUCTION

The emergence of agriculture had a major impact on humanity. People began to manage the production and availability of food. The consequence of agriculture was the establishment of the first human settlements, changing the hunter-gatherers of food into farmers. Since then agriculture have dominated the activities of humanity for the last thousands of years until the industrial revolution. Even with the advent of the information and communication technology (ICT) era, the importance of agriculture is not reduced because agriculture is about producing food and humanity cannot live without food. Agriculture has developed and evolved through progressive innovation over the years. After the Second World War, it was necessary to provide food for the increase in world's population as fast as possible. Farm machineries were built and created for these purposes. Since then, technological developments in agriculture have contributed tremendously to the world food production. Ecological, sustainable, organic or conservation farming have been developed to encourage the responsible use of soils and

to prevent the degradation of the land so that future generations can continue to reap its rewards. Precision farming technology is used to optimise the application of fertilisers to reduce wastage and to minimise groundwater effects. Satellite remote sensing is used to detect weed or insect damage during the growing season to allow precise application of pesticides. Towards the new era of agriculture production, robotics technology is introduced to graduate substitute human. The topic of discussion in this paper focuses on robotics algorithm design formulation.

## EXPERIMENTAL STUDY OF THE LOCOMOTION OF MICROGRAVITY ROBOT IN THE LABORATORY

NASA's Microgravity Research Division supports both ground-based and flight experiments requiring microgravity conditions of varying duration and quality [3].

Xang Sheng Xu, 1992, in his paper has discussed an active compensation system that modulates the tension in a counterweight support cable in order to minimise state

deviation between the compensated body and the ideal weightless [4].

The Zero-G robot is designed for running in zero-gravity. Normally it is impossible to run without gravity, because the upward motion that initiates the flight phase cannot be reversed once contact with the ground is lost. One way to overcome this limitation is to run between two parallel rebound surfaces. In this case, the supporting forces generated in the collision with one surface reverse the vertical velocity generated during collision with the other surface. Such a configuration for running might occur in a space station, where the walls could act as the rebound surfaces [2].

From the above reviews, conclude that if the system manages to the counter the weight in the direction of the locomotion or movement and as the same time in free moving condition, then this condition can be considered as moving in free drag force. In this condition, it can be said that the robot arms are moving in the weightlessness environment and condition.

## METHODOLOGY

This research uses the previous mentioned concept and it comprises an analytical and experimental study of space robot locomotion, but in this paper the analytical results are presented only. The 2-DOF SCARA type robot, with servo motors as the drivers are built and the pneumatic jet air is used to compensate the gravity force by placing the nozzles on the robot's arm as the air-bearing. The base of the robot will be setting on a smooth horizontal grass base, this system provides the drag-free and near "zero gravity" characteristics of space in two dimensions for the robot arms shown in Figure 1.

Some formulas to calculate viscous drag and gas flow are illustrated in the next paragraph. For a round flat-bottomed base with outer radius  $r_o$ , plenum radius  $r$ ; and center of mass located at the geometrical center, the drag force  $D$  is:

$$D = \frac{\mu\pi}{h} (r_o^2 - r_i^2)^A v^{B*} \quad (1)$$

$$\frac{\mu\pi}{h} (r_o^2 - r_i^2) = 0.0004 \text{ [N-s/m]}$$

where  $\mu$  is the coefficient of viscosity of the gas (air),  $h$  is the thickness of the air bearing (500  $\mu\text{m}$  nominal) and  $v^{A*}$  is the velocity of the center of the base plate with respect to the inertial frame. With a mass of 1.5 kg, this corresponds to a time constant of approximately 10 minutes. The flow rate  $Q$  is given by:

$$Q = \frac{mgh^3}{3\mu(r_o^2 - r_i^2)} \quad (2)$$

Equation 2 shows that the flow rate needed to float the robot increases with the cube of the gap thickness and decreases linearly with the area of the base. [1]

In the electronic design, servomotors are used; control of a AC brushless servomotor requires the main frame of the motor, angle and angular velocity detectors, current, voltage and magnetic flux detectors, a transistor PWM inverter and a semiconductor power converter including analogue and digital ICs for controlling those equipment.

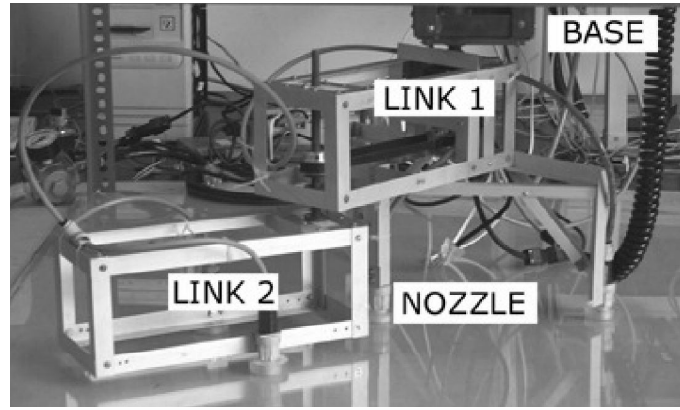

Figure 1: Structure overview

Provided that the three-phases currents have a phase difference of  $120^\circ$  to each other:

$$\begin{aligned} T(\text{Torque}) &= B I I_o \\ &= I_r (B_o \sin \theta \cdot I_u + \\ &\quad B_o \sin(\theta + 120^\circ) \cdot I_v + \\ &\quad B_o \sin(\theta + 120^\circ) \cdot I_w) \\ &= 3/2 B_o I_o I_r \end{aligned} \quad (3)$$

$I_o$  is the maximum value of current,  $I_u$ ,  $I_v$ ,  $I_w$  are currents of phases U, V and W, respectively.  $\theta$  is the motor's angle of rotation.  $B_o$  is the maximum value of magnetic flux Density.  $L$  is the length of rotor.  $R$  is the diameter of rotor.

Therefore orthogonal control of current and magnetic flux can be performed first by detecting the rotational position  $\theta$  of the rotor and then by controlling the currents of the three-phase windings on the basis of Equation 3. It is also possible to control the amount of torque freely by controlling the value of  $I_o$ . Thus to get back the torque value at the motor operation time by measuring the currents of the three-phase consumed by the motor [4].

## KINEMATICS EQUATIONS OF THE LINKS

The D-H representation of a rigid link depends on four geometric parameters associated with each link. All the kinematics link parameter are presented in Table 1.

Table 1: Kinematics links parameter

Joint i	$\theta_i$	$d_i$	$\alpha_i$	$a_i$
1	var	0	0	230.5mm
2	var	-50mm	0	270mm

where  $\alpha_i$ ,  $a_i$ ,  $d_i$ , are constants while  $\theta_i$  is the joint variable for a revolute joint.

Since all joints are revolute, the homogenous transformation matrix defined in Equation 5 has the same structure for each joint, computation the direct kinematics function as in Equation 6.

$$A_i^{i-1}(\theta_i) = \begin{bmatrix} c_i & -s_i & 0 & a_i c_i \\ s_i & c_i & 0 & a_i s_i \\ 0 & 0 & 1 & 0 \\ 0 & 0 & 0 & 1 \end{bmatrix} \quad i=1,2. \quad (5)$$

$$T_2^0(q) = A_1^0 A_2^1 = \begin{bmatrix} c_{12} & -s_{12} & 0 & a_1 c_1 + a_2 c_{12} \\ s_{12} & c_{12} & 0 & a_1 s_1 + a_2 s_{12} \\ 0 & 0 & 1 & 0 \\ 0 & 0 & 0 & 1 \end{bmatrix} \quad (6)$$

where  $q = [\theta_1 \ \theta_2]^T$ ,  $s_i = \sin \theta_i$ ,  $s_{12} = \sin(\theta_1 + \theta_2)$ ,  $c_{12} = \cos(\theta_1 + \theta_2)$ .

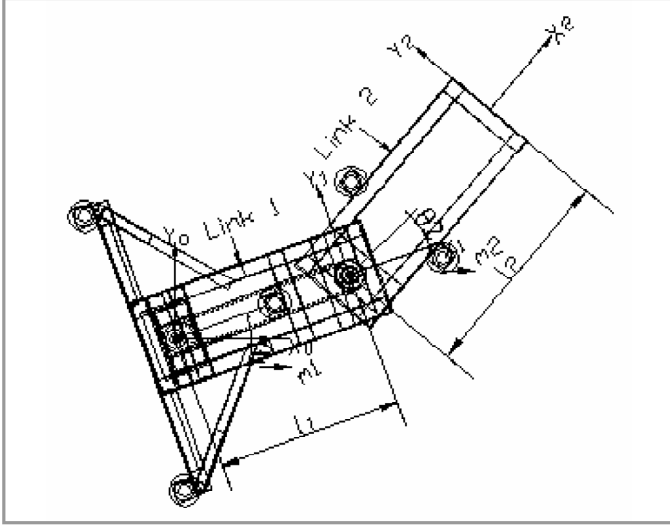

Figure 2: Parameters in links

## DYNAMIC CALCULATIONS

Newton-Euler formulation is used for the dynamics calculations. With variables defined in Figure 2, in the absence of friction and other disturbances, the dynamics of a rigid manipulator can be written as

$$\tau = H(q)\ddot{q} + C(q, \dot{q}) + G(q) \quad (7)$$

where  $q$  and  $\tau$  are  $n \times 1$  vectors of joint displacements and applied joint torques(or forces), respectively.  $H(q)$  is the  $n \times n$  symmetric positive-definite(s.p.d) manipulator inertia matrix,  $C(q, \dot{q})$  is the  $n \times 1$  vector of centripetal and Coriolis torques, and  $G(q)$  is the  $n \times 1$  vector of gravitational torques [2].

From the torques calculation, the inertial, Coriolis and centrifugal and gravitational effects on links can be found.

The inertial effect on link 1:

$$\frac{1}{8}[(m_1 l_1^2 + m_2 l_2^2 + 8m_2 l_1^2 + m_2 l_1 l_2 c_2) \ddot{\theta}_1 + (m_2 l_2^2 + 2l_1 l_2 m_2 c_2) \ddot{\theta}_2] \quad (8)$$

The inertial effect on link 2:

$$\frac{1}{8} m_2 l_2 [(l_2 + 2l_1 c_2) \ddot{\theta}_1 + l_2 \ddot{\theta}_2] \quad (9)$$

The coriolis and centrifugal effect on link 1:

$$-\frac{1}{4} m_2 l_1 l_2 \dot{\theta}_2 (2s_1 \dot{\theta}_1 + s_2 \dot{\theta}_2) \quad (10)$$

$$\frac{1}{4} m_2 l_2 l_1 s_2 \dot{\theta}_1^2 \quad \text{1 centrifugal effect on link 2:} \quad (11)$$

$$\frac{1}{4} g(m_1 l_1 s_1 + 4m_2 l_1 s_1 + m_2 l_2 s_{12}) \quad (12)$$

$$\frac{1}{4} m_2 l_2 g s_{12} \quad \text{gravitational effect on link 2:} \quad (13)$$

As in the weightlessness condition the gravitational effects will be compensated, thus there will no gravitational effects on the links.

$$\tau_1 = \begin{bmatrix} \frac{1}{8} [-2m_2 l_1 l_2 \dot{\theta}_2 (2s_1 \dot{\theta}_1 + s_2 \dot{\theta}_2) \\ + (m_1 l_1^2 + m_2 l_2^2 + 8m_2 l_1^2 + m_2 l_1 l_2 c_2) \ddot{\theta}_1 \\ + (m_2 l_2^2 + 2l_1 l_2 m_2 c_2) \ddot{\theta}_2] \end{bmatrix} \quad (14)$$

$$\tau_2 = \begin{bmatrix} \frac{1}{8} m_2 l_2 [2l_1 s_2 \dot{\theta}_1^2 + (l_2 + 2l_1 c_2) \ddot{\theta}_1 + l_2 \ddot{\theta}_2] \end{bmatrix} \quad (15)$$

## RESULTS AND DISCUSSION

The data are obtained from the mechanical simulation and virtual prototyping software, Mechanical Desktop 4 combined with MSC Working Model. The results are divided into 2 categories, with and without the gravitational effect with link 2 moving are only compared with the data taken from hardware:

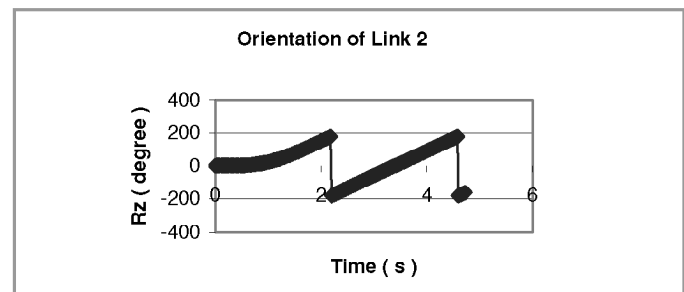

Figure 3: The orientation profile of link 2

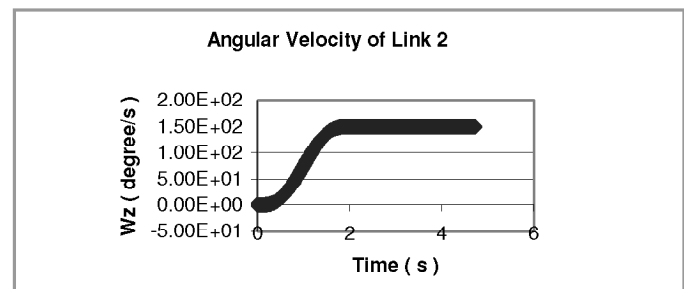

Figure 4: The angular velocity profile of link 2

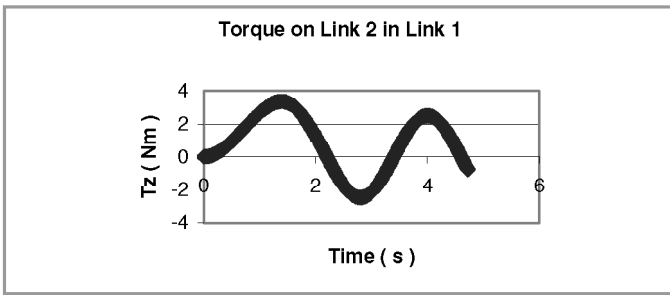

Figure 5: The torque profile of joint 2

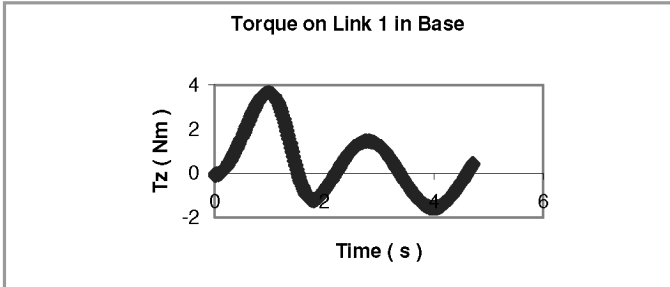

Figure 6: Torque profile of joint 1

The following figures show link 2 moving only with the gravitational effect:

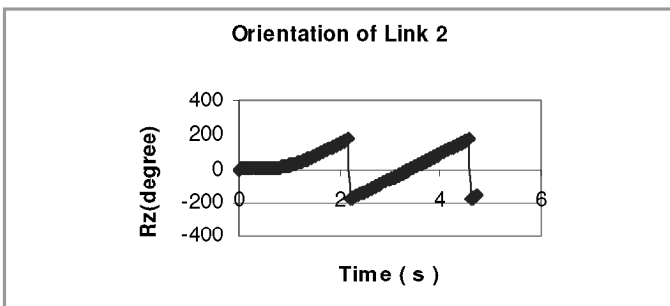

Figure 7: Orientation profile of link 2

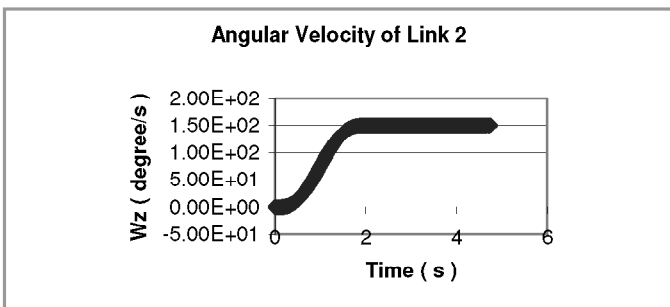

Figure 8: Angular velocity of link 2

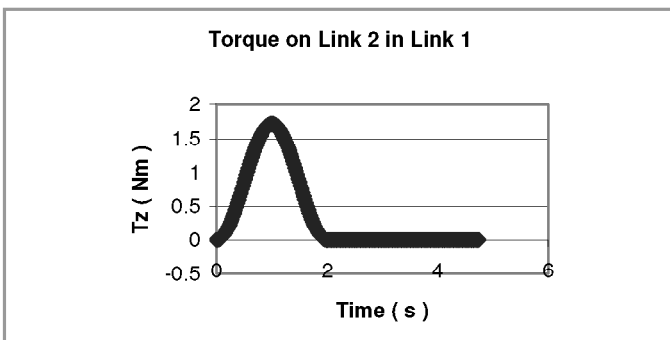

Figure 9: Torque profile of joint 2

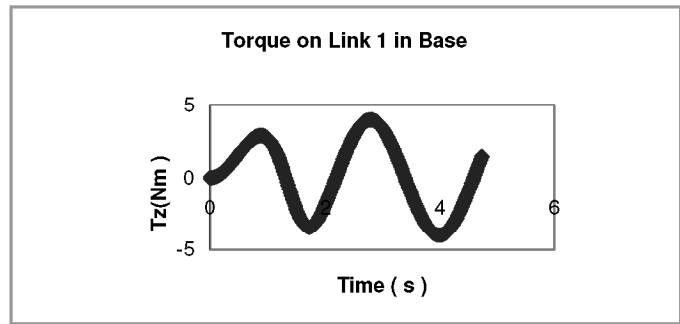

Figure 10: Torque profile of joint 1

The following figures show link 2 moving only without gravitational effect:

Based on the simulation results, the Figures 3 and 7 show the orientation angle, RZ around Z axis, the Figures 4 and 8 show the angular velocity WZ around Z axis in the unit of degree/s. Figure 5, the sinuous form is caused by the gravitational and coriolis and centrifugal effect, whereas higher torque at the beginning is caused by the inertia effect. But it is different in Figure 9, with the absent of gravity force effect, when the acceleration of joint 2 become zero, the torque will decrease until zero according Equation 15. From the Equations 12 and 14, the gravitational and coriolis and centrifugal effect are compensating each other, and Figure 6 and Figure 10 clearly verify the equations as torque in Figure 6 less than Figure 10 when joint 2 achieved constant angular velocity.

## CONCLUSION

The analytical study of the issues involved in creating "weightlessness" locomotion for the robotic in laboratory including dynamics equation, simulation of the gravitational effect and the hardware setup are discussed. All the profile patterns are acceptable with the comparison of the calculations shown in the derived dynamics equations and thus verified the successful of the research. From the results shown, the algorithm formulation has been verified by the setup of the experimental and can be used in especially robotics motion including positioning control that is kinematics and force control that is dynamics design. Over the next ten years, the available machines will be redesigned, extended and optimised. Operation that relies on human intelligence and ability are quite difficult to automate. Hopefully, advanced technology from industrial automation can be adapted and modified to create the next generation machines that can replace humans in the more complex tasks which include 3-dimension sensor information, artificial intelligence, complex manipulators and fast and accurate eye-hand coordination especially in robotics area of studies. Such technical innovations may take 5 to 10 years or even longer from initial idea to market introduction. Meanwhile, agricultural engineering research and development work should work closely with the growers. ■

## REFERENCES

- [1] Jasper W.J., Experiments in Thrusterless Robot Locomotion Control for Space applications, PhD thesis,Staford University,1990.

- [2] Raibert M. H., Brown H. B., Jr.,  
"ChepponisDynamically Stable Legged Locomotion, AI  
Technical Report 1179, Massachusetts Institute of  
Technology, (September 1985-September 1989).
- [3] The Microgravity Research Division (MRD) of NASA's  
Office of Life and Microgravity Sciences and  
Applications (OLMSA)-August 1997, updated April 1999).
- [4] Yangsheng Xu, "An active Z gravity compensation  
system", The Robotics Institute, Carnegie Mellon  
University, 1992.
- [5] Yasuhiko Dote, Sakan Kinoshita, Brushless Servomotor  
Fundamental and Applications, Oxford, Clarendon  
Press, 1990.

## PROFILE



**Engr. Ten Seng Teik**  
Mechanization and Automation Research Centre,  
MARDI, P.O.BOX 12301,  
General Post Office  
50774 Kuala Lumpur  
Tel: 603-89436275 Fax: 603-89482961  
E-mail: stten@mardi.my

*Qualification:*

- B.Eng (Mechanical / System), UPM, 1999
- M. Sc (Robotics), Institute of Advanced  
Technology, UPM, 2001

*Experience*

- Currently the Research Officer in Mechanization  
and Automation Research Centre at the Malaysian  
Agricultural Research and Development Institute  
(MARDI).
- Research areas: Robotics and automation in  
agriculture, automatics bulk paddy sampling  
system, mechanization system in kenaf harvesting  
and drying technology.