

CHAPTER 4

RESULTS

4.1 Introduction

In this chapter focus are given more on WDM system. The results which are obtained mainly from the simulation work are presented. In simulation analysis, the study will be on the development of a new spectral slicing WDM system. The results are taken from the studies on the effect of distance, bit rate, input power and chip spacing.

4.2 Simulation Setup for New Spectral Slicing WDM System

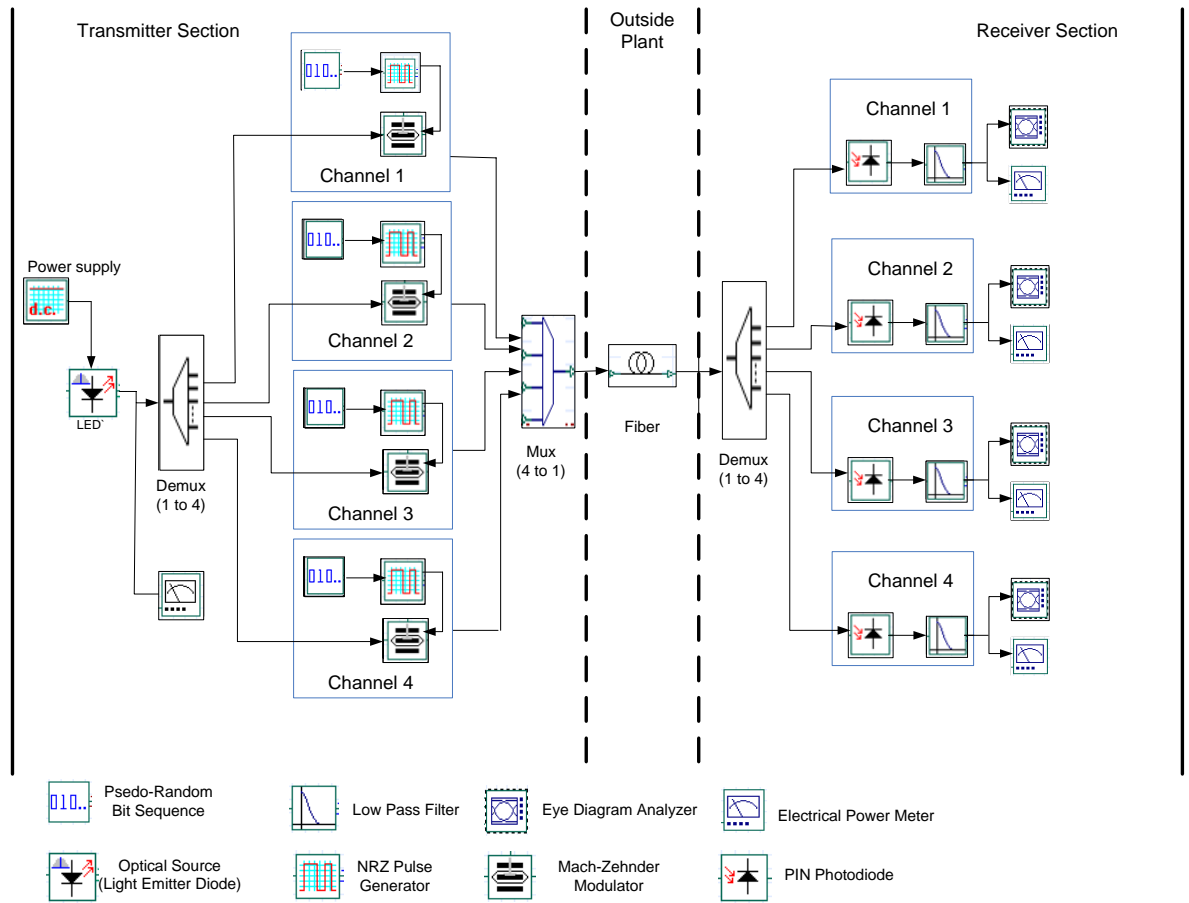

Figure 4.1: Layout Design

4.2.1 List of Component Used

1) Bias Generator

A d.c. source.

2) Light Emitting Diode

Simulate a modulated LED. In this model, the mean of the optical power is a function of the modulation current (Input signal).

3) WDM Demux 1X4

The input signal is split into four signals that are filtered by an optical filter. The optical filter can be a Rectangle, Gaussian, or Bessel optical filter. The level of crosstalk for both MUX and DEMUX components, is defined by bandwidth, ripple, and depth of the filter. These 3 factors will determine how much power, from neighboring channels; will act as crosstalk terms when calculating the performance of a specific channel. The most important parameter is depth, as it will play the most significant role in determining the power levels of the neighboring channels.

4) WDM Mux 4X1

The four input signals are filtered by an optical filter and are combined in one signal. The optical filter can be a Rectangle, Gaussian, or Bessel optical filter.

5) Pseudo-Random Bit Sequence Generator

Generate a Pseudo Random Binary Sequence (PRBS) according to different operation modes. The bit sequence is designed to approximate the characteristics of random data.

6) NRZ Pulse Generator

Generate a Non Return to Zero (NRZ) coded signal.

7) Mach-Zehnder Modulator

Simulate a Mach-Zehnder modulator using an analytical model. The Mach-Zehnder modulator is an intensity modulator based on an interferometric principle. It consists of two 3 dB couplers which are connected by two waveguides of equal length. By means of an electro-optic effect, an externally applied voltage can be used to vary the refractive indices in the waveguide branches. The different paths can lead to constructive and destructive interference at the output, depending on the applied voltage. Then the output intensity can be modulated according to the voltage.

8) Optical Fiber

The optical fiber component simulates the propagation of an optical field in a singlemode fiber with the dispersive and nonlinear effects taken into account by a direct numerical integration of the modified nonlinear Schrödinger (NLS) equation (when the scalar case is considered) and a system of two, coupled NLS equations when the polarization state of the signal is arbitrary.

9) Photodetector PIN

The incoming optical signal and noise bins are filtered by an ideal rectangle filter to reduce the number of samples in the electrical signal. The new sample rate is defined by the parameter Sample rate. You can define the center frequency, or it can be calculated automatically by centering the filter at the optical channel with maximum power.

10) Low Pass Bessel Filter

Filter with a Bessel frequency transfer function.

11) BER Analyzer

After run a simulation, the visualizers in the project generate graphs and results based on the signal input. The graphs and results can be access from the Project Browser or by double-clicking a visualizer in the Main Layout.

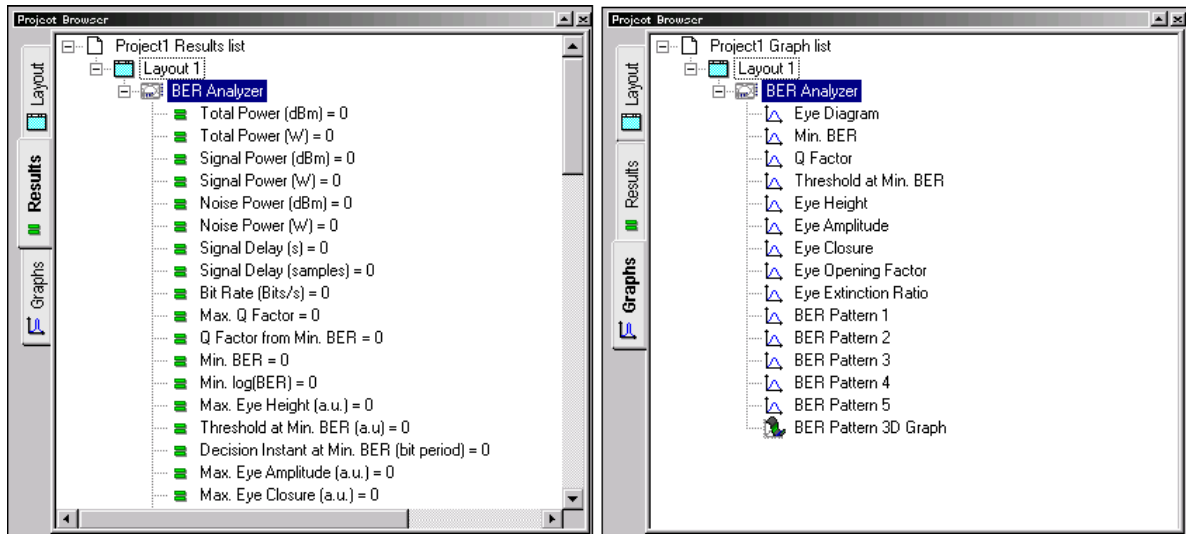

Figure 4.2: Project browser

The BER Analyzer estimates and analyzes the BER of the signal received. Double click the BER Analyzer to access the parameters, graphs, and results from the simulation see Figure below.

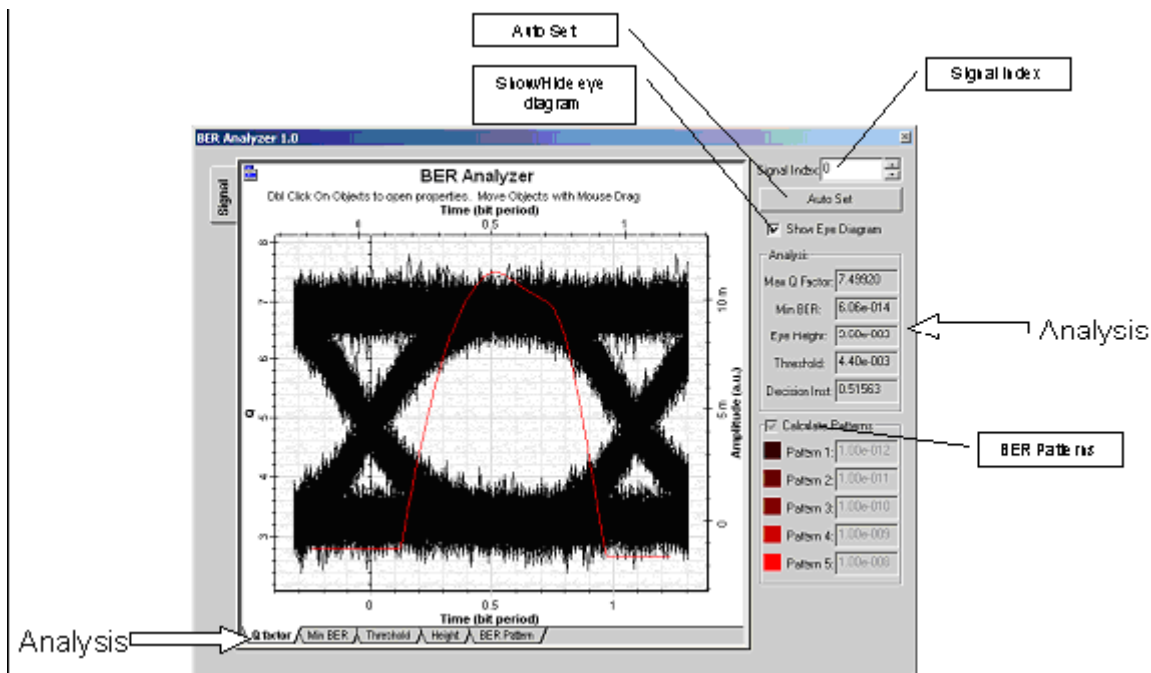

Figure 4.3: BER Analyzer display

Use the signal index to select the signal to display from the signal buffer

The available results are:

- **Max Q-factor:** Maximum value for the Q-factor in the eye time window.
- **Min BER:** Minimum value for the bit error rate in the eye time window.
- **Eye height:** Maximum value for the eye height in the eye time window.
- **Threshold:** Value of the threshold at the decision instant for the maximum Qfactor / minimum BER.

4.3 Simulation Result for New Spectral Slicing WDM System

In this section, the results from the simulation for new spectral slicing WDM system are presented. The results are taken from the studies on the effect of a set design parameters. The distance, bit rate, the input power and the spectral width. The results demonstrate the performance of spectral slicing in WDM system.

4.3.1 Effect of Distance on System Performance

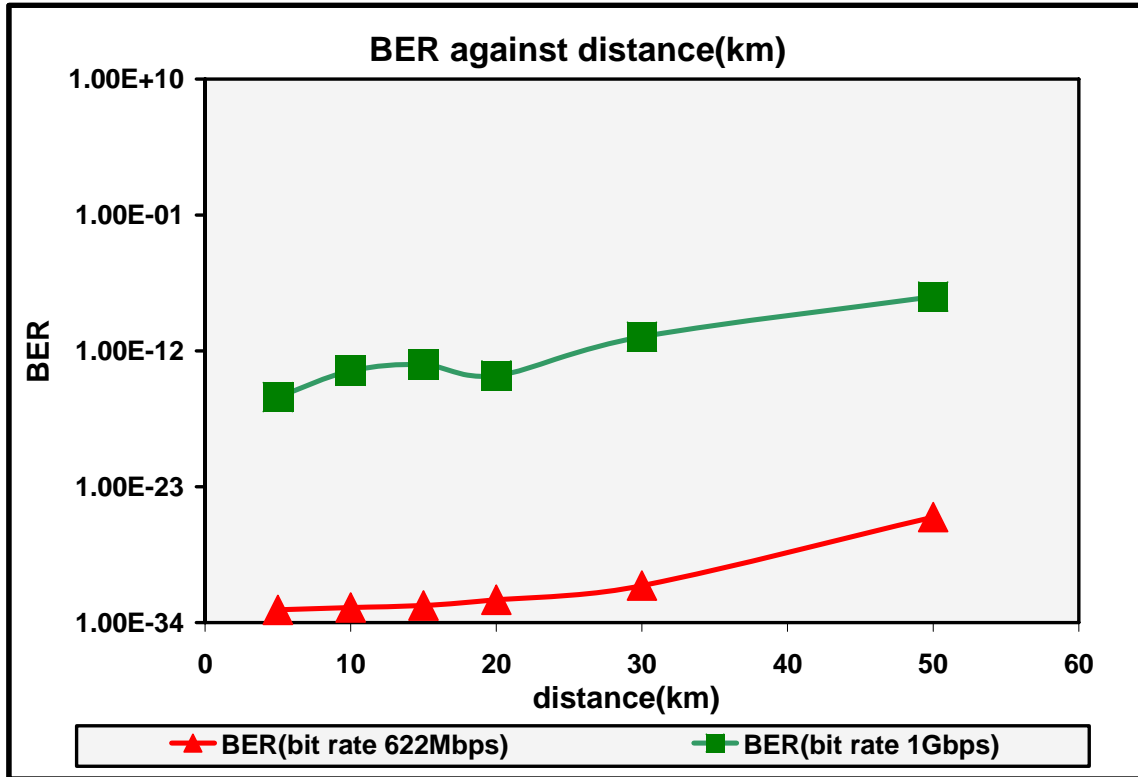

Figure 4.4: BER against Distance at Different Bit

Usually a longer fiber will provide a larger dispersion and attenuation, thus increasing the bit error rate. For WDM system using spectral slicing, as a result the subtraction process, the system will significantly compensate the dispersion effect and therefore the performances are limited by the fiber losses. The figure 4.4 shows the BER against the distance at different bit rate. The BER increased exponentially with distance. The WDM system performs sufficiently well up to 30km and 50km for both 622 Mbps and 1 Gbps. Over all the performance for 622 Mbps is better than 1 Gbps because it's increasing very smoothly. The result above clearly shows that WDM system suitable for metro and long distance networks.

4.3.2 Effect of Chip Spacing on System Performance

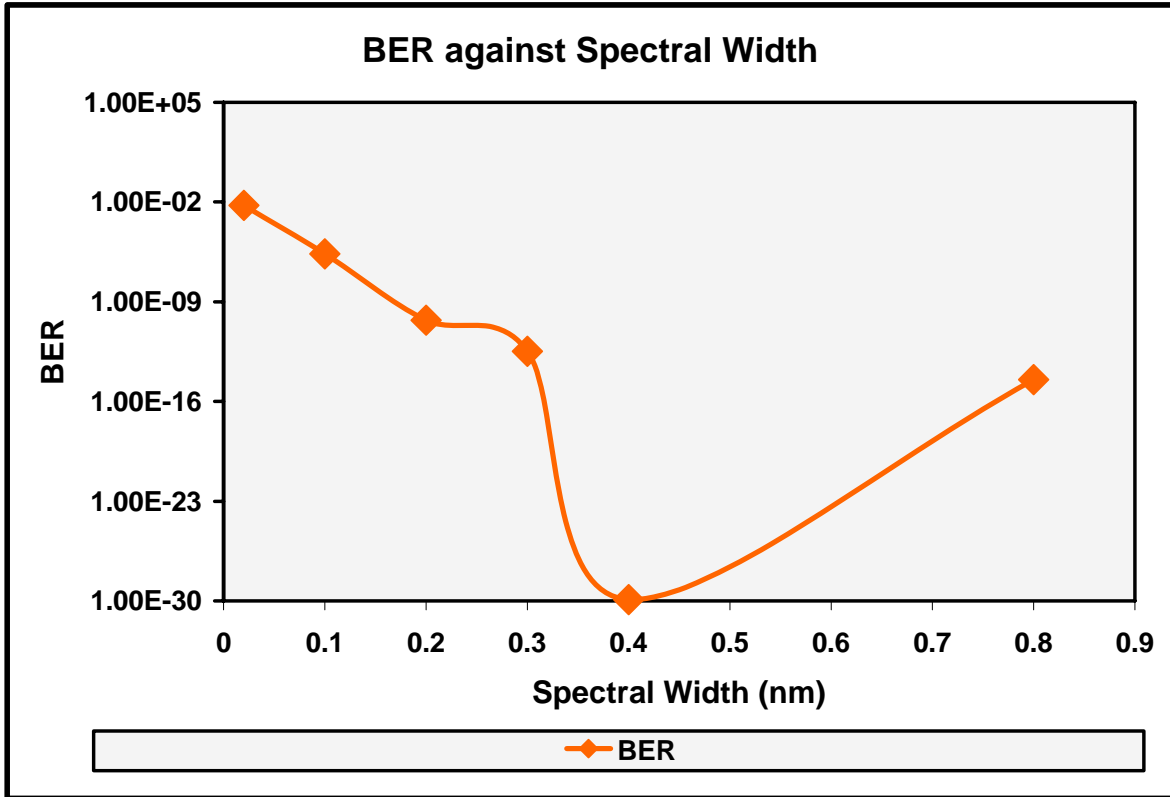

Figure 4.5: BER against Spectral Width at Bit rate of 622 Mbps

Chip spacing is one of the important design parameter in this project. Multi-wavelength transmission using fiber is subjected to many effects. The nonlinear interactions, mixing, and wavelength dependent parameters in the fiber are the limiting factors in the system. Four-wave mixing and the cross phase modulation the main nonlinear parameters considered in this project. In this project the spacing was varied from 0.02 nm to 0.8 nm, to study the effect of the chip spacing on the system performance.

The effect of chip spacing is shown in Figure 4.5. As shown by the simulation results, the system gave the best performance (lower BER) at the chip spacing of 0.3nm to 0.8 nm. The reason is because when the spacing less than 0.3 nm, the system subjected to crosstalk effect and the performance reduced. This performance is for 50 km and bit rate of 622 Mbps.

Ideally, all the light emitted from an LED would be at the peak wavelength, but in practice the light is emitted in a range of wavelengths centered at the peak wavelength. This range is called the spectral width of the source.

4.3.3 Effect of Bit Rate on System Performance

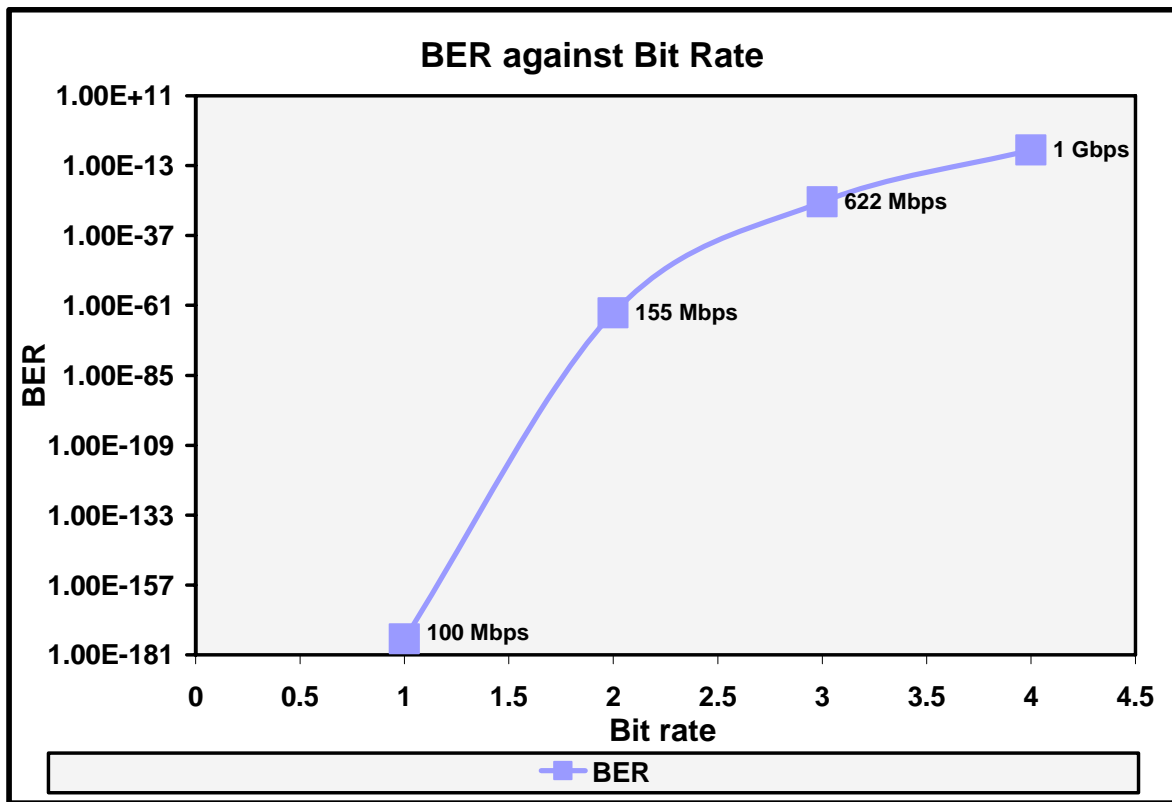

Figure 4.6: BER against Bit rate

In the simulation, the transmission bit rate was varied by changing the numerical values in the dialog box at the transmitter section. A range of bit rate from 100 Mbps to 1 Gbps was chosen for the simulation. The fiber length was set at 50 km and spectral width was 0.4 nm and all other parameters were made constant.

The effect of bit rate is shown in Figure 4.6. In the figure, the error rate increase exponentially with bit rate. This can be explained as follows. Increasing the bit rate will decrease the pulse width, thus making the bits more sensitive to dispersion effect. The result shows that, at the fixed distance of 50 km the WDM system could support bit rate up to 622 Mbps. At 1 Gbps though, the bit rate become too fast for the system and was not supported well.

Light emitters are a key element in any fiber optic system. This component converts the electrical signal into a corresponding light signal that can be injected into the fiber. The light emitter is an important element because it is often the most costly element in the system, and its characteristics often strongly influence the final performance limits of a given link.

The LEDs used in fiber optics different from the more common indicator LEDs in two ways. The wavelength is generally in the near infrared (because the optical loss of fiber is lowest at these wavelengths) and LED emitting area is generally much smaller in order to allow the highest possible modulation bandwidth and improve the coupling efficiency with small core optical fibers. Nonlinearity in LEDs causes harmonic distortion in the analog signal that is transmitted over an analog fiber optic link. Example of fiber nonlinearities includes FWM.

4.3.4 Effect of Input Power on System Performance at Bit Rate 622 Mbps

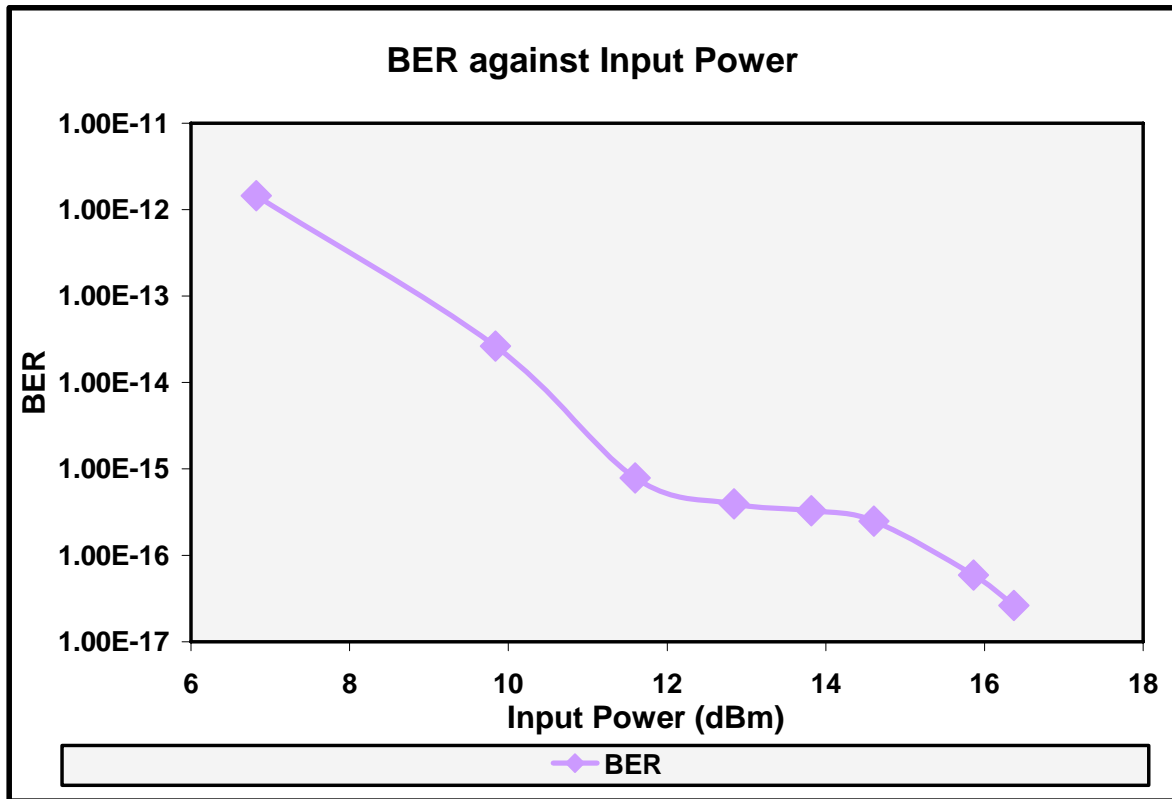

Figure 4.7: BER against Input Power for WDM system at Bit Rate of 622 Mbps

If the signal is too weak when it reaches the far end of the system the data will be difficult to separate from the noise. This will cause the number of errors in the received data bits to increase. The problem can be solved by keeping the input power or the transmitter power to a maximum value.

This is the wavelength at which the source emits the most power. It should be matched to the wavelengths that are transmitted with the least attenuation through optical fiber. From the result the BER reduced exponentially when the input power increased. The performance of the WDM system can be improved by increasing the input power.

4.3.5 Effect of Output Power on System Performance at Bit Rate 622 Mbps

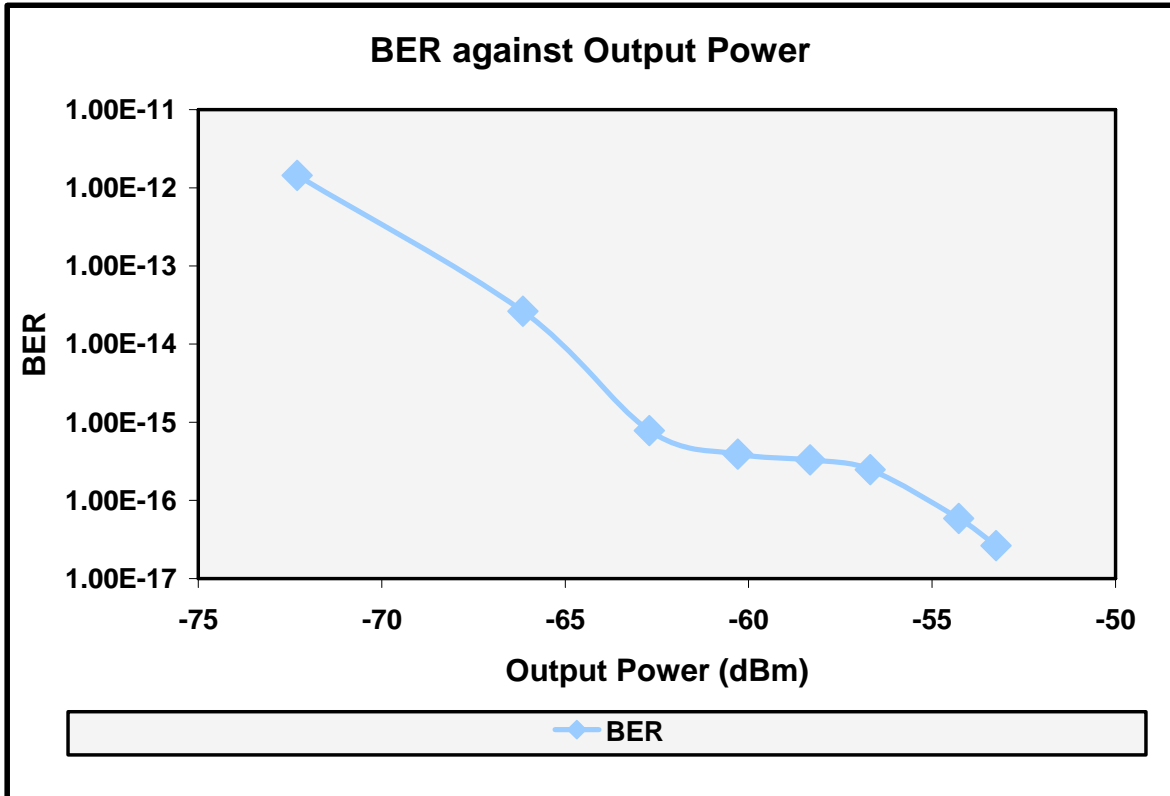

Figure 4.8: BER against Output Power for WDM system at Bit Rate of 622 Mbps

The above figure shows the BER against output power at receiver section. It clearly shows that the BER reduced exponentially when the output power increased.

The best results are usually achieved by coupling as much of a source's power into the fiber as possible. The key requirement is that the output power of the source be strong enough to provide sufficient power to the detector at the receiving end, considering fiber attenuation; the decrease in signal strength along a fiber optic waveguide caused by absorption and scattering. Attenuation is usually expressed in dB/km, coupling losses and other system constraints. Output power for LED is it linearly proportional to drive current.