

Transmission Loss Allocation in Deregulated Power System Using the Hybrid Genetic Algorithm-Support Vector Machine Technique

M.W. Mustafa, M. H. Sulaiman, H. Shareef, and S. N. Abd. Khalid

Abstract—This paper proposes a new method to trace the transmission loss in deregulated power system by incorporating the Genetic Algorithm (GA) and Least Squares Support Vector Machine (LS-SVM). The idea is to use GA to find the optimal values of hyper-parameters of LS-SVM and adopts a supervised learning approach to train the LS-SVM model. The proportional sharing method (PSM) is proposed to trace the transmission loss at each transmission line which is then utilized as a teacher in the proposed hybrid technique called GA-SVM method. Based on load profile as inputs and PSM output for transmission loss allocation, the GA-SVM model is expected to learn which generators are responsible for transmission losses. In this paper, 4-bus system and IEEE 14-bus system are used to show the effectiveness of the proposed method.

Index Terms—Deregulation, genetic algorithm, proportional sharing method, support vector machine, transmission loss allocation

I. INTRODUCTION

ELECTRICITY markets around the world are currently in transition towards deregulated and competitive markets. The changes and evolutions are initiated by several factors such as realization that generation and distribution functions need not be monopolies, the cost reduction potential of competition and the development of new technologies in power generation and information technology. Basically, there are a lot of issues to take into accounts when deregulation is planned to be implemented by any countries. For example, the role of existing power industry; how to reconfigure the system when the changes of law and the justification of market power that will be executed. Deregulation is just not involving privatization and integration of existing industry with other

power producer, but it also involving the pricing and allocation problem. Not to forget the ancillary services that really important to support the basic generating capacity, energy supply and power delivery. The UK pioneered deregulation and has been introducing full competition in its energy market. This is based on the belief that regulated utilities know better how to make efficiency improvements when they are given the incentive to make them. However, not all countries follow the reform as in the UK; many others prefer to introduce competition in generation with the centrally operated transmission system. The motives are obvious, viz. efficient operation is essential to profit making and inefficiency is eradicated through competition [1].

The rise of independent power producers have resulted in the exploitation of different resources. The energy that flows into the meshed network to the loads need to be traced and the loss in transmission networks need to be charged and apportion to which generator/ load transparently. This is not an easy task due to nonlinear characteristic of energy flow and losses in the network.

A number of works on transmission loss allocation have been reported in literature. One of the simplest techniques is Pro-Rata (PR) technique where the technique is quite well known used in mainland Spain [2]. However, this technique ignores the system configuration and the losses are globally allocated to producers and customers through proportional allocation rule. The method that uses Z-Bus matrix in loss tracing has been proposed in [3]. In this technique, the loss allocation technique is expressed in terms of the Z-Bus matrix and current injection instead of power injection. Reference [4] proposed three different methods to allocate the loss, viz. by using proportional, quadratic and geometric allocation. However, it is ended up without proofing which one is the correct method. The proportional sharing method (PSM) has been used to develop different methods for power tracing algorithms [5-6]. In these methods, the power flow from generators and or loads are traced to determine the transmission usage in the system. Then, transmission losses caused by each generator or load are determined.

The method that uses superposition theorem to trace the power flow and loss allocation has been proposed in [7]. The method proposed an integration of Y-Bus matrix with the equivalent impedance of load bus before the integration matrix

Manuscript received January 5, 2011. This work was supported by Ministry of Higher Education (MOHE), Malaysia

M. W. Mustafa and S. N. Abd. Khalid are with the Faculty of Electrical Engineering, Universiti Teknologi Malaysia, Johor 81310, Malaysia (email: wazir@fke.utm.my, nizam@fke.utm.my).

M. H. Sulaiman is with the School of Electrical System Engineering, Universiti Malaysia Perlis (UniMAP), 01000 Kangar, Perlis Malaysia. (phone: +6049851608; fax: +604-9851431; email: mherwan@unimap.edu.my).

H. Shareef is with the Faculty of Electrical Engineering and Build Environment, Universiti Kebangsaan Malaysia, Bangi 43600, Malaysia. (email: shareef@eng.ukm.my).

is inversed into Z-Bus. This information then is used for loss tracing using superposition theorem. Nevertheless, this method assumes that the current at each network injection point may flow through all line and all loads, which can be argued. The method called proportional tree method (PTM) has been proposed to trace the power flow and loss in deregulated power system [8]. This method based on proportional concept [5] and quite time consuming. Two methods, incremental load flow approach (ILFA) and marginal transmission loss approach (MTLA) to determine the transmission loss allocation have been proposed in [9]. MTLA is based on Krons' loss formula, while ILFA uses the modified load flow calculation to assess transmission loss allocation in iterative way.

In related work based on Artificial Intelligence technique, [10, 11] have proposed Artificial Neural Network (ANN) approach to trace the loss. Ref. [10] uses Z-Bus loss allocation technique; while in [11] ILFA is used as a teacher to train the ANN model in training stage. ANN also has been incorporated in reactive power transfer allocation problem [12]. However, for this particular problem, it would be very time consuming at training stage due to large data of power network. Support vector machines (SVM) technique offers a fast solution to overcome this problem. Unlike ANN, which tries to define complex functions of input feature space, SVM perform a nonlinear mapping of the data into high dimensional feature space. In related work, a SVM was applied to estimate dynamic voltage collapse index in power system [13]. The results show that SVM gives faster and approximately accurate result for dynamic voltage collapse prediction.

From the literature reviews, it can be seen that the proposed methodology that adopts the hybridization of GA and LS-SVM into transmission loss allocation problem is unique and has not being applied. The new transmission loss allocation method is based on manipulation of PSM and the introduction of virtual load concept before incorporating GA-SVM to calculate the contributions of individual generators to the losses, which are described in the following sections.

II. PROPORTIONAL SHARING METHOD

A. Tracing principle

The purpose of power flow tracing is to determine the distribution factors of power injection to each bus on the outflow branches, or to identify the contribution factors of each generator to each load and loss on the basis of AC power flow computation. The concept of proportional sharing method is proposed by Bialek [5], where the summation of inflows are equal to the outflows at each node or bus and the each outflow is proportionate with the sum of inflows. This concept can be illustrated as shown in Fig. 1. In Fig. 1, it can be seen that the total power flow through the node is $P_i = 40 + 60 = 100$ MW of which 40% is supplied by line $j-i$ and 60% by line $k-i$. On the other hand, each of the outflows down the line from node i depends only on the voltage gradient and

impedance of the line. Hence, as electricity is an indistinguishable commodity, it may be assumed that each MW leaving the node contains the same proportion of inflows as the total nodal P_i . Hence the 70 MW outflowing in line $i-m$ consists of $70 \frac{40}{100} = 28$ MW supplied by line $j-i$ and

$70 \frac{60}{100} = 42$ MW supplied by line $k-i$ whilst the 30 MW

outflowing in line $i-l$ consists of $30 \frac{40}{100} = 12$ MW supplied

by line $j-i$ and $30 \frac{60}{100} = 18$ MW supplied by line $k-i$ [5].

Based on this consideration, an extended method of loss tracing is proposed in this paper.

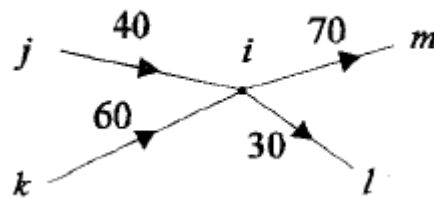

Fig. 1. Proportional sharing principle [5].

B. Proposed transmission loss allocation method

The development process of proposed method can be illustrated with a small power network with AC power solution as shown in Fig. 2. To apply this concept, the test system must be constructed into lossless system. This research proposes a different view how the lossless system can be obtained, which is by removing the loss at each line and that particular loss is attributed to the sending end bus as a virtual load. The proposed modification is depicted in Fig. 3.

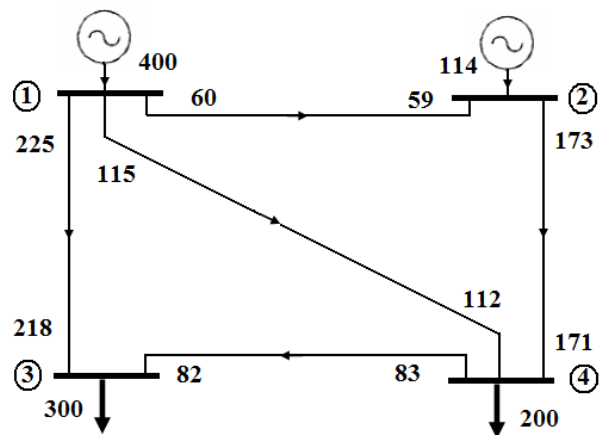

Fig. 2. 4-bus test system with the real power flows in MW

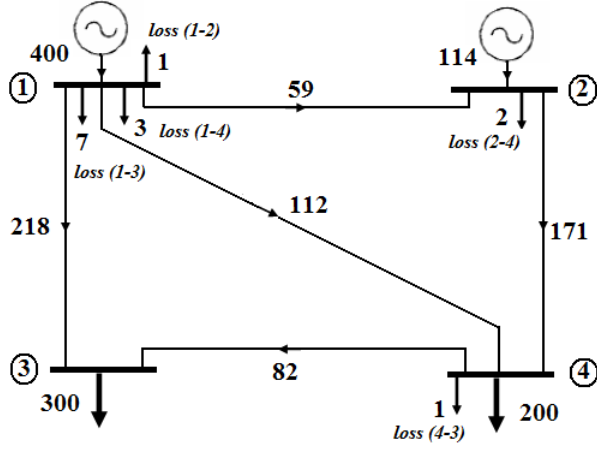

Fig. 3. Lossless system with attributed losses to the sending end bus (virtual load)

After lossless system is constructed, PSM is applied, which is the distribution matrix, A_P is created as follows [5]:

$$[A_P] = \begin{cases} 1 & \text{for } i = j \\ -c_{ji} = -\frac{|P_{j-i}|}{P_j} & \text{for } j \in \alpha_i \\ 0 & \text{otherwise} \end{cases} \quad (1)$$

where P_j is representing of the total power flow through bus j , α_i is the set of buses supplying directly to bus i and $|P_{j-i}|$ is the magnitude of power flow (receiving end) at line $j-i$. From distribution matrix A_P , the shares of generators to the losses (virtual loads) can be calculated as follow:

$$P_{LVk}^{Gi} = \frac{|P_{Gi}|}{P_i} \sum_{k=1}^n [A_P^{-1}]_{ik} \left(\sum_{m=1}^{nline} P_{LVk}^m \right) \quad (2)$$

where A_P^{-1} is inversion of matrix A_P , P_{Gi} is real power generated by bus i , P_i is through power of bus i , P_{LVk}^m is virtual load at bus k for line m and $nline$ is the total line that attached with bus k . Finally, the individual generators' contribution to each line loss can be obtained as follow:

$$Loss_{i-j}^{Gi} = \frac{Loss_{i-j}}{\left(\sum_{m=1}^{nline} P_{LVk}^m \right)} \cdot P_{LVk}^{Gi} \quad (3)$$

Vector $Loss_{i-j}^{Gi}$ then is used as a target in the training process of proposed GA-SVM technique.

III. FUNCTION ESTIMATION USING LS-SVM

Support vector machine (SVM) is known as a powerful methodology for solving problems in nonlinear classification, function estimation and density estimation. SVM has been introduced within the context of statistical learning theory and structural risk minimization (SRM). Least squares support vector machine (LS-SVM) is reformulations from standard

SVM [14] which lead to solving linear Karush-Kuhn-Tucker (KKT) systems. LS-SVM is closely related to regularization networks and Gaussian processes but additionally emphasizes and exploits primal-dual interpretations [15].

In LS-SVM function estimation, the standard framework is based on a primal-dual formulation. Given N dataset $\{x_i, y_i\}_{i=1}^N$, the goal is to estimate a model of the form:

$$y(x) = w^T \varphi(x) + b + e_i \quad (4)$$

where $x \in R^n$, $y \in R$ and $\varphi(\cdot) : R^n \rightarrow R^{n_h}$ is a mapping to a high dimensional feature space. The following optimization problem is formulated:

$$\min_{w,b,e} J(w,e) = \frac{1}{2} w^T w + \gamma \frac{1}{2} \sum_{i=1}^N e_i^2 \quad (5)$$

s.t. $y_i = w^T \varphi(x_i) + b + e_i, i=1, \dots, N$.

With the application of Mercer's theorem [14] for the kernel matrix Ω as $\Omega_{ij} = K(x_i, x_j) = \varphi(x_i)^T \varphi(x_j)$, $i, j=1, \dots, N$ it is not required to compute explicitly the nonlinear mapping $\varphi(\cdot)$ as this is done implicitly through the use of positive definite kernel functions K [16].

From the Lagrangian function:

$$\zeta(w, b, e, \beta) = \frac{1}{2} w^T w + \gamma \frac{1}{2} \sum_{i=1}^N e_i^2 - \quad (6)$$

$$\sum_{i=1}^N \beta_i (w^T \varphi(x_i) + b + e_i - y_i)$$

Differentiating (6) with w , b , e_i and β_i , the conditions for optimality can be described as follow:

$$\left\{ \begin{array}{l} \frac{d\zeta}{dw} = 0 \rightarrow w = \sum_{i=1}^N \beta_i \varphi(x_i) \\ \frac{d\zeta}{db} = 0 \rightarrow \sum_{i=1}^N \beta_i = 0 \\ \frac{d\zeta}{de_i} = 0 \rightarrow \beta_i = \gamma e_i, i=1, \dots, N \\ \frac{d\zeta}{d\beta_i} = 0 \rightarrow y_i = w^T \varphi(x_i) + b + e_i \end{array} \right. \quad (7)$$

By elimination of w and e_i , the following linear system is obtained [16]:

$$\left[\begin{array}{c|c} 0 & 1^T \\ \hline y & \Omega + \gamma^{-1} I \end{array} \right] \begin{bmatrix} b \\ \beta \end{bmatrix} = \begin{bmatrix} 0 \\ y \end{bmatrix} \quad (8)$$

with $y = [y_1, \dots, y_N]^T$, $\beta = [\beta_1, \dots, \beta_N]^T$. The resulting LS-SVM

model in dual space becomes:

$$y(x) = \sum_{i=1}^N \beta_i K(x, x_i) + b \quad (9)$$

Usually, the training of the LS-SVM model involves an optimal selection of kernel parameters and regularization parameter. For this paper, the RBF Kernel is used which is expressed as:

$$K(x, x_i) = e^{-\frac{\|x-x_i\|^2}{2\sigma^2}} \quad (10)$$

Note that σ^2 is a parameter associated with RBF function which has to be tuned.

IV. GENETIC ALGORITHM

In general, genetic algorithm (GA) is known as a subset of evolutionary algorithms that model biological processes that influenced by the environmental factor to solve a various numerical optimization problems. GA allows a population composed of many individuals to evolve under specified selection rules to a state that maximizes the “fitness” (i.e. minimizes the cost) function. The method was developed by Holland [17] and popularized by Goldberg [18, 19]. Traditionally, GA is using a binary number as a representation, but recently, the using of floating and real numbers as representation is become popular [20, 21].

A. Representation

In this paper, floating numbers are used as representation of the chromosome. If the chromosome has N_{par} parameters (an N -dimensional optimization problem) given by $p_1, p_2, \dots, p_{N_{par}}$, then the single chromosome is written as an array with $1 \times N_{par}$ elements as follows:

$$chromosome = [p_1, p_2, p_3, \dots, p_{N_{par}}] \quad (11)$$

B. Initialization

GA does not work with a single string but with a population of strings, which evolves iteratively by generating new individuals taking the place of their parents. Normally, the initial population is generated at random.

C. Evaluation function

The performance of each string is evaluated according to its fitness. Fitness is used to provide a measure of how individuals have performed in the problem domain. The choice of objective and fitness function is proposed in the next section.

D. Genetic operators

With an initial population of individuals and evaluated through its fitness, the operators of GA begin to generate a new and improved population from the old one. A simple GA

consists of three basic operations: selection, crossover and mutation.

Selection determines which individuals are chosen for crossover and a process in which individual chromosomes are copied according to their fitness. Parents are selected according to their fitness performance and this can be done through several methods. For this paper, *roulette wheel* selection method is used [18].

Crossover is a process after the parents chromosomes are selected from *roulette wheel* method. It is a process that each individual will exchange information to create new structure of chromosome called offspring. In this paper, the combination of an extrapolation and crossover methods are used [20]. It begins by randomly selecting a parameter in the first pair of parents to be crossover at point:

$$\alpha = round\{random * N_{par}\} \quad (12)$$

Let

$$parent_1 = [p_{m1}, p_{m2}, \dots, p_{m\alpha}, \dots, p_{mN_{par}}] \quad (13)$$

$$parent_2 = [p_{d1}, p_{d2}, \dots, p_{d\alpha}, \dots, p_{dN_{par}}] \quad (14)$$

where m and d subscripts discriminate between the *mom* and *dad* parent. Then the selected parameters are combined to form new parameters that will appear in the offspring, as follow:

$$p_{new1} = p_{m\alpha} - \beta[p_{m\alpha} - p_{d\alpha}] \quad (15)$$

$$p_{new2} = p_{d\alpha} + \beta[p_{m\alpha} - p_{d\alpha}] \quad (16)$$

where β is also a random value between 0 and 1. The final step is to complete the crossover with the rest of the chromosome, as follow:

$$offspring_1 = [p_{m1}, p_{m2}, \dots, p_{new1}, \dots, p_{mN_{par}}] \quad (17)$$

$$offspring_2 = [p_{d1}, p_{d2}, \dots, p_{new2}, \dots, p_{dN_{par}}] \quad (18)$$

Although selection and crossover are applied to chromosome in each generation to obtain a new set for better solutions, occasionally they may become overzealous and lose some useful information. To protect these irrecoverable loss or premature convergence occur, mutation is applied. Mutation is random alteration of parameters with small probability called probability of mutation (0-10%). Multiplying the mutation rate by the total number of parameters gives the number of parameters that should be mutated. Next, random numbers are chosen to select of the row and columns of the parameters to be mutated. A mutated parameter is replaced by a new random parameter.

V. GA-SVM FOR TRANSMISSION LOSS ALLOCATION PROBLEM

The proposed tracing method is elaborated by designing an appropriate GA-SVM model using LS-SVMlab Toolbox [22] for the modified IEEE 14-bus system as shown in Fig. 4. This test system can be obtained in [23]. This system consists of 14 buses and 20 transmission lines. The modification has been

made for this test system. Initially, the synchronous condensers at bus 3, 4 and 5 are only supporting the reactive power supply for the system. For this case, these synchronous condensers are treated and work as normal generators to alleviate the real power support at bus 1. In addition, the modification is made to show that GA-SVM can give acceptable solution even for the larger system with more than two generators. The input samples for training is assembled using daily load curve and performing load flow analysis for every hour of load demand. Input data (D) for developed GA-SVM contains independent variables, viz. real power generation except slack bus (P_{g2} to P_{g5}) and real and reactive load demands at each hour. At the other hand, the output/target parameter, (T) is the real power contributions from individual generator to transmission losses. This is considered as 100 outputs (5 generators' contributions to 20 transmission lines).

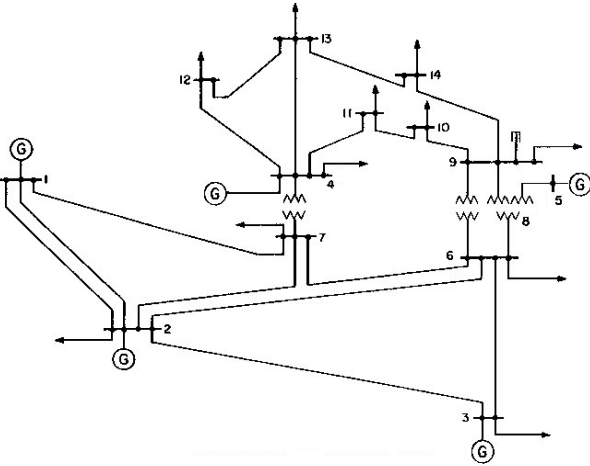

Fig. 4. Modified IEEE 14-bus system

Before incorporated GA into LS-SVM, two factors need to be considered: (1) coding the variables into a finite string or chromosome and (2) mapping the objective function into a fitness form. The variables of the optimal values of regularization parameter, γ and Kernel RBF parameter, σ^2 are coded in the following manner. At first, each variable X is coded as the continuous floating numbers that range from 0 to 1. Then, the variables are concatenated to construct a multivariable string. The candidate of solutions or chromosomes is shown in Fig. 5. The main objective is to find the best combination of these two variables that will produces good generalization of LS-SVM. The evaluation process is done by using these two values in LS-SVM model for training and testing to obtain the mean squares error (MSE) between the output and the target that have been created. The objective function is the value of MSE to be minimized, H as follows:

$$H = \min(MSE) \quad (19)$$

After evaluating each chromosome, the objective function in equation (19) is transformed and normalized to a fitness scheme to be maximized as follows:

$$f = \frac{1}{1+H} \quad (20)$$

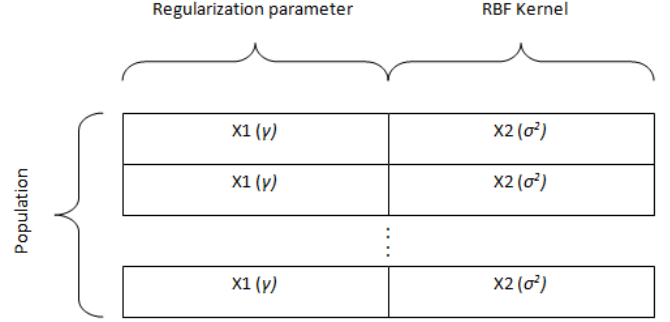

Fig. 5. Chromosomes

For the GA operators, the single point arithmetic crossover method is adapted from the modification of extrapolation and crossover method [20]. The GA properties to find the optimal γ and σ^2 are as follow:

- Selection: *roulette wheel*
- Crossover probability = 0.9
- Mutation probability = 0.1
- Population = 20
- Maximum iteration = 30

The process of incorporation of GA-SVM is shown in Fig. 6.

VI. COMPUTATIONAL RESULTS

A. 4-Bus System

Bialek [5, 6] has proposed PSM for power tracing methodology. The same convention is followed with simple manipulation of distribution matrices, A_P^{-1} to suit the transmission loss allocation purpose. In order to verify the veracity of this approach, a numerical calculation is performed for 4-bus system shown in Fig. 1. After obtaining lossless system (Fig. 3), the matrix A_P and A_P^{-1} can be constructed as follow:

$$[A_P] = \begin{bmatrix} 1 & \frac{-59}{173} & \frac{-218}{300} & \frac{-122}{283} \\ 0 & 1 & 0 & \frac{-171}{283} \\ 0 & 0 & 1 & 0 \\ 0 & 0 & \frac{-82}{300} & 1 \end{bmatrix}$$

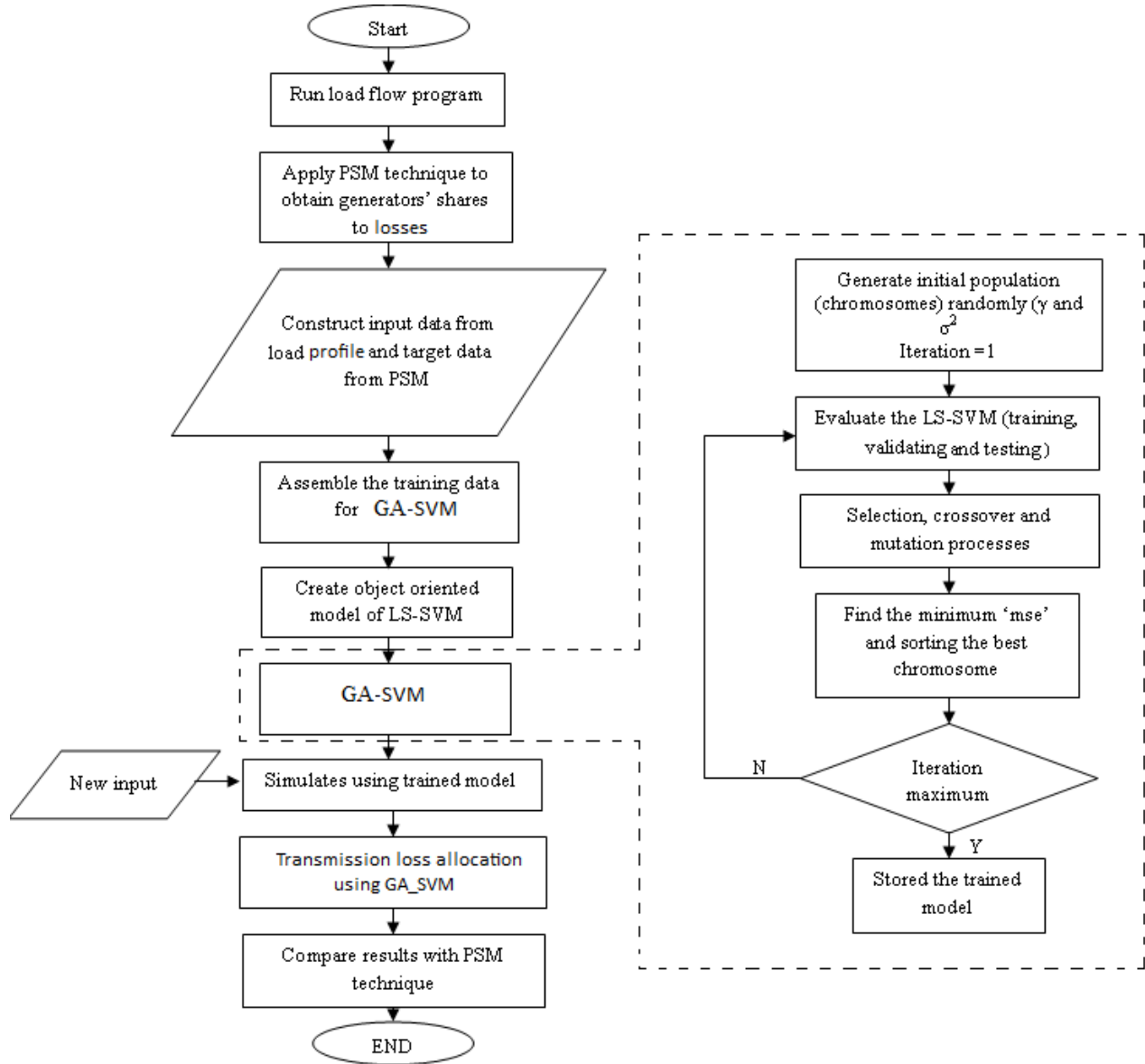

Fig. 6. Flow of GA-SVM

$$[A_P^{-1}] = \begin{bmatrix} 1 & 0.341 & 0.8912 & 0.6018 \\ 0 & 1 & 0.1652 & 0.6042 \\ 0 & 0 & 1 & 0 \\ 0 & 0 & 0.2733 & 1 \end{bmatrix}$$

The purpose of virtual load is to make the system lossless and then treated as a virtual load. In order to obtain the contribution of G1 and G2 to line losses (virtual loads), equations (2) and (3) are used and the calculations are demonstrated in Table 1 and Table 2.

TABLE I

TRACING RESULTS OF VIRTUAL LOADS				
Share of generator\ Load	Load (v1)	Load (v2)	Load (v4)	Total
P_{G1}	(400/400) x 1 x 11 = 11	(400/400) x 0.341 x 2 = 0.682	(400/400) x 0.6018 x 1 = 0.6018	12.28
P_{G2}	(114/173) x 0 x 11 = 0	(114/173) x 1 x 2 = 1.3179	(114/173) x 0.6042 x 1 = 0.3981	1.72
Total	11	2	1	14

TABLE II
TRACING RESULTS OF LINE LOSS

Line	G1	G2	Total
1-2	$(1/11) \times 11 = 1$	$(1/11) \times 0 = 0$	1
1-3	$(7/11) \times 11 = 7$	$(7/11) \times 0 = 0$	7
1-4	$(3/11) \times 11 = 3$	$(3/11) \times 0 = 0$	3
2-4	$(2/2) \times 0.682 = 0.682$	$(2/2) \times 1.3179 = 1.3179$	2
4-3	$(1/1) \times 0.6018 = 0.6018$	$(1/1) \times 0.3981 = 0.3981$	1
Total	12.28	1.72	14

From these tables, it can be seen that the results are same as the power flow solution as shown in Fig. 2.

B. IEEE 14-bus system incorporating GA-SVM technique

Training, validation and testing processes

After the input and target of training data have been created, the next step is to divide the data (D and T) up into training, validation, testing subsets. In this case, 96 samples (57%) of data are used for the training, 24 samples (14%) for validation and 48 samples (29%) for testing out of 168 hours. Table 3 shows the numbers of samples of training, testing and validation.

TABLE III
THE NUMBER OF SAMPLES FOR TRAINING, VALIDATION AND TESTING SETS

Data Types	Samples (Hour)
Training	(1-72), (121-144)
Validation	(145-168)
Testing	(73-120)

The property of regularization parameter γ and Kernel RBF σ^2 are decided through the GA technique that has been discussed above. The mean square error (MSE) vs. iteration is depicted in Fig. 7. From the model of GA-SVM, the final value of γ is set to 9138.2 and σ^2 is set to 9668.9 yields a reasonable accuracy of the output of the predictive model that has been designed. Figs. 8, 9 and 10 show the training, validation and testing performances for the function estimation of GA-SVM model. The model's output is indicated by the solid line whereas the target is indicated by the points *. To ensure the accuracy of GA-SVM, the targets are modified into kW unit, instead of MW. The MSE for validation is 1.5468 and for testing process is 1.5325 which show that the estimation by GA-SVM model and the training data points having the similar characteristics.

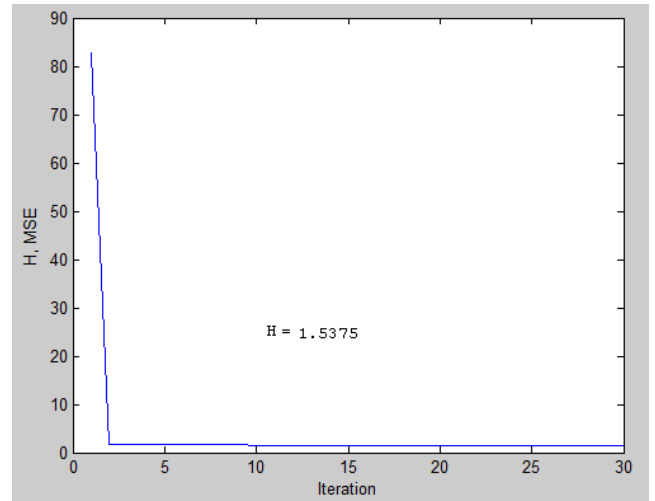

Fig. 7. MSE vs. Iteration

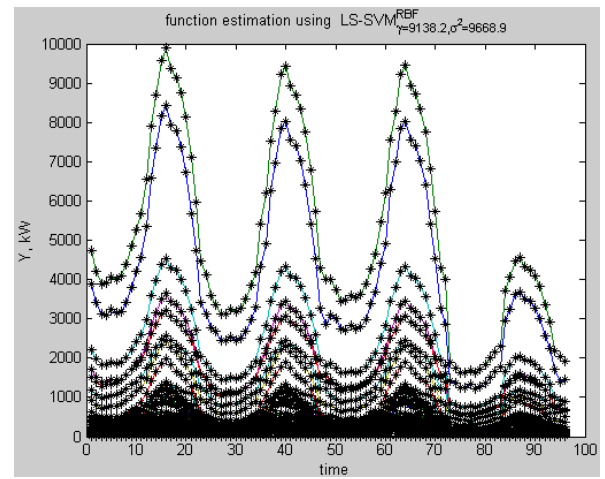

Fig. 8. Training for 96 samples data

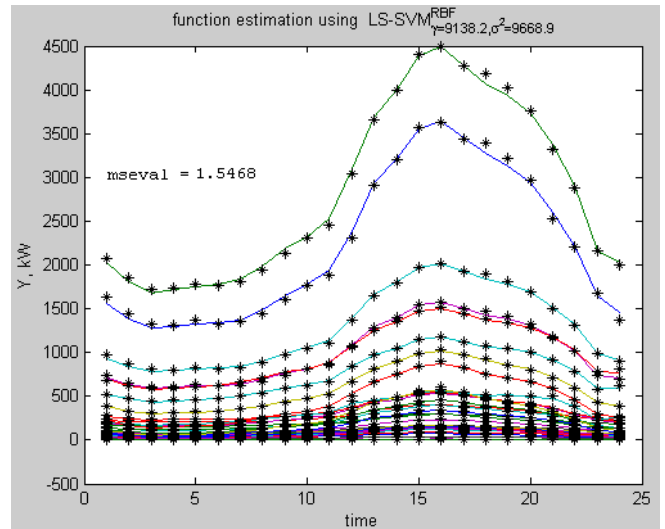

Fig. 9. Validation for 24 samples data

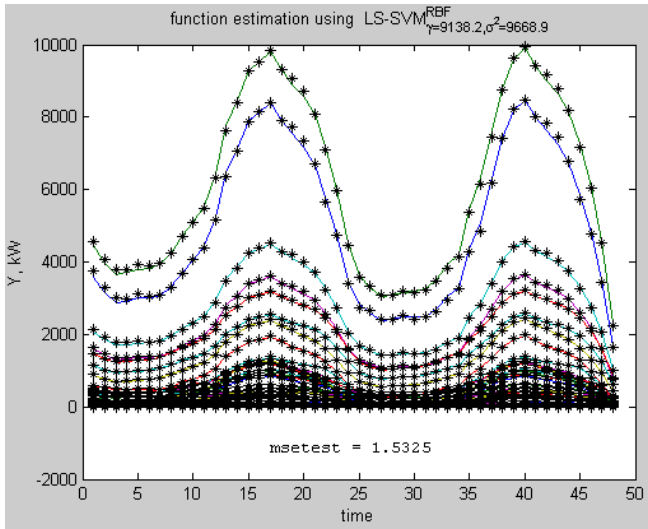

Fig. 10. Testing for 48 samples data

Pre-testing

After GA-SVM model has been trained in MATLAB, the next step is to simulate the model. The entire sample data are used in pre-testing. After simulation, the obtained result from the trained model is evaluated with the linear regression analysis. The regression analysis that refers to contribution of Generator 2 to line loss at line 2-6 is shown in Fig. 11. In this figure, the x-axis refers to the target from PSM and the y-axis refers to the simulation results from GA-SVM. The correlation coefficient, (R) for this case is equal to one indicates the perfect correlation between trained GA-SVM with the PSM results. The best linear fit indicated by solid line, whereas the perfect fit indicated by the dashed line.

Simulation

The case scenario is that real and reactive power at each load is assumed to decrease by 10% from hour 1 to 168, from the nominal trained pattern. This also assumed that all generators also decrease their production proportionally according to the variation of demands. The allocation from generators to loss using PSM and proposed GA-SVM technique on hours 12 out of 168 hours are tabulated in Table 5. The results obtained by GA-SVM are compared well with the results from PSM. The largest difference between generators is 0.0037 MW at line 1-7 for G1. Overall performance of GA-SVM can be said very successful since the model's predictions are close to the PSM even just using about 57% from the overall data. Moreover, the GA-SVM model computes the results within 295 ms whereas the PSM took about 1.4787 seconds to calculate the same transmission loss allocation. Better computation time is crucial to improve online application. For that, the GA-SVM provides the results in a faster manner with acceptable accuracy. Table 4 shows the converged bus and line solutions for IEEE 14-bus system on hours 12.

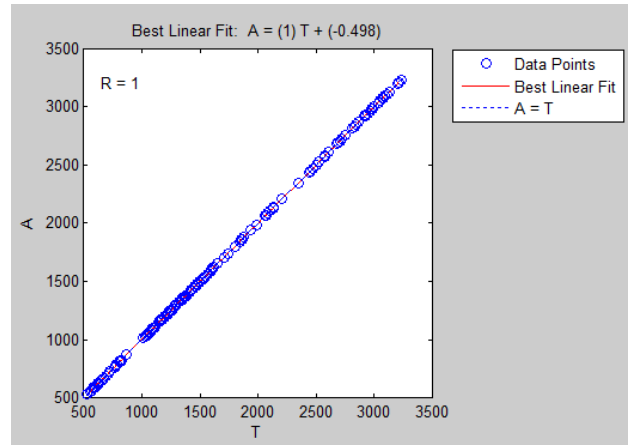

Fig. 11. Regression analysis between hybrid GA-SVM output and corresponding target

TABLE IV-A
BUS DATA FOR IEEE 14-BUS SYSTEM ON HOURS 12

Bus No	Voltage		Generation		Load	
	Mag (pu)	Angle (deg)	P (MW)	Q (Mvar)	P (MW)	Q (Mvar)
1	1.06	0	256.0725	-1.6807	0	0
2	1.045	-4.9026	112.7205	71.3776	55.9305	10.5678
3	1.01	-9.3349	76.7205	12.2635	81.324	17.5788
4	1.07	-24.3116	58.7205	75.272	37.1385	6.8058
5	1.09	-15.5272	40.7205	36.4263	0	0
6	0.9804	-12.9595	0	0	69.4575	14.2614
7	0.9854	-11.8971	0	0	31.671	5.13
8	1.0332	-19.1788	0	0	0	0
9	1.0234	-24.814	0	0	59.4135	10.2942
10	1.0092	-26.4572	0	0	35.964	6.6006
11	1.0163	-26.6465	0	0	28.755	9.4734
12	0.9997	-27.288	0	0	28.998	17.0658
13	1.009	-27.6529	0	0	41.3505	9.234
14	0.9712	-30.239	0	0	49.329	3.8304

TABLE IV-B
CONVERGED LINE SOLUTION FOR IEEE 14-BUS SYSTEM ON HOURS 12

From Bus	To Bus	From Bus Injection		To Bus Injection		Loss	
		P (MW)	Q (Mvar)	P (MW)	Q (Mvar)	P (MW)	Q (Mvar)
1	2	154.46	-16.87	150.30	-29.59	4.16	12.71
1	7	101.61	20.92	96.43	-0.44	5.18	21.36
2	3	43.51	9.74	42.66	6.14	0.86	3.60
2	6	86.54	15.48	82.43	3.00	4.11	12.48
2	7	77.03	15.02	73.82	5.22	3.21	9.81
3	6	38.05	3.71	37.09	1.26	0.96	2.45
7	6	42.08	-1.43	41.84	-2.20	0.24	0.77
6	8	53.66	-11.82	53.66	-18.10	0.00	6.28
6	9	38.25	1.86	38.25	-6.10	0.00	7.97
7	4	96.50	5.15	96.50	-15.91	0.00	21.06
4	11	29.54	15.21	28.62	13.30	0.92	1.92

4	12	29.34	15.87	28.14	13.39	1.19	2.49
4	13	59.21	21.47	56.91	16.96	2.29	4.51
5	8	40.72	36.43	40.72	32.00	0.00	4.43
8	9	94.38	13.90	94.38	4.52	0.00	9.38
9	10	36.52	3.89	36.11	2.81	0.41	1.09
9	14	36.70	4.13	35.04	0.61	1.66	3.52
10	11	0.14	-3.80	0.13	-3.82	0.01	0.03
13	12	0.89	3.71	0.85	3.68	0.03	0.03
13	14	14.68	4.02	14.29	3.22	0.39	0.79

VII. CONCLUSION

This paper has presented a new methodology to allocate the generators' contributions to transmission losses in deregulated power system. Initially, the virtual load concept is proposed before PSM is applied in the loss tracing paradigm. Then the transmission loss allocation procedure is extended by proposing the hybridization of LS-SVM technique with Genetic Algorithm. The developed GA-SVM adopts transmission loss allocation outputs determined by PSM as an estimator to train the model. The robustness of the proposed method has been demonstrated on IEEE 14-bus system. The results show the advantage of GA-SVM compared to PSM in term of computational time. Better computational time is crucial to improve online application. The proposed, GA-SVM technique provides the results in a faster and convenient manner with good accuracy. Thus, the proposed methodology could be adopted into real application of power system deregulation, especially in pool based market.

ACKNOWLEDGMENT

The authors wish to acknowledge the Ministry of Higher Education (MOHE), Malaysia for the funding of this project.

REFERENCES

- [1] Lai LL, *Power system restructuring and deregulation: trading, performance and information technology*. Chichester: John Wiley & Sons, 2001.
- [2] A. J. Conejo, J. M. Arroyo, N. Alguacil, and A. L. Guijarro, "Transmission loss allocation: a comparison of different practical algorithms," *Power Systems, IEEE Transactions on*, vol. 17, pp. 571-576, 2002.
- [3] A. J. Conejo, F. D. Galiana, and I. Kockar, "Z-bus loss allocation," *Power Systems, IEEE Transactions on*, vol. 16, pp. 105-110, 2001.
- [4] A. Gomez Exposito, J. M. Riquelme Santos, T. Gonzalez Garcia, and E. A. Ruiz Velasco, "Fair allocation of transmission power losses," *Power Systems, IEEE Transactions on*, vol. 15, pp. 184-188, 2000.
- [5] J. Bialek, "Tracing the flow of electricity," *Generation, Transmission and Distribution, IEE Proceedings-*, vol. 143, pp. 313-320, 1996.
- [6] J. Bialek, "Topological generation and load distribution factors for supplement charge allocation in transmission open access," *Power Systems, IEEE Transactions on*, vol. 12, pp. 1185-1193, 1997.
- [7] Teng J-H. "Power flow and loss allocation for deregulated transmission systems", *International Journal of Electrical Power & Energy Systems* pp.327-327, 2005.
- [8] M. H. Sulaiman, M. W. Mustafa, and O. Aliman, "Power flow and loss tracing in deregulated transmission system using proportional tree

- method," *International Review of Electrical Engineering (IREE)*, vol. 3, pp. 691-698, 2008.
- [9] A. Bhuiya and N. Chowdhury, "Allocation of transmission losses in a deregulated power system network," in *Electrical and Computer Engineering, 1999 IEEE Canadian Conference on*, 1999, pp. 1148-1152 vol.2.
- [10] S. Arunachalam, M. Ramesh Babu, K. Mohanadasse, and S. Ramamoorthy, "ANN based Z-bus loss allocation for pool dispatch in deregulated power system," in *Power India Conference, 2006 IEEE*, 2006.
- [11] R. Haque and N. Chowdhury, "An artificial neural network based transmission loss allocation for bilateral contracts," in *Electrical and Computer Engineering, 2005. Canadian Conference on*, 2005, pp. 2203-2207.
- [12] M. W. Mustafa, S. N. Khalid, H. Shareef, and A. Khairuddin, "Reactive power transfer allocation method with the application of artificial neural network," *Generation, Transmission & Distribution, IET*, vol. 2, pp. 402-413, 2008.
- [13] M. Nizam, A. Mohamed, M. Al-Dabbagh, and A. Hussain, "Dynamic voltage collapse prediction in a practical power system with support vector machine," in *TENCON 2008 - 2008 IEEE Region 10 Conference*, 2008, pp. 1-6.
- [14] V. N. Vapnik, *The Nature of Statistical Learning Theory 2nd ed*. New York, 1995.
- [15] M. Espinoza, J. Suykens, and B. Moor, "Fixed-size Least Squares Support Vector Machines: A Large Scale Application in Electrical Load Forecasting," *Computational Management Science*, vol. 3, pp. 113-129, 2006.
- [16] J. A. K. Suykens, T. V. Gestel, J. De Brabanter, B. De Moor, and J. Vandewalle, *Least Squares Support Vector Machines*. Singapore: World Scientific, 2002.
- [17] Holland JH. *Adaptation in natural and artificial systems: an introductory analysis with applications to biology, control, and artificial intelligence*. London: MIT Press, 1992.
- [18] Goldberg DE. *Genetic algorithms in search, optimization, and machine learning*. Reading, Mass.: Addison-Wesley, 1989.
- [19] Goldberg DE. *The design of innovation: lessons from and for competent genetic algorithms*. Boston: Kluwer Academic Publishers, 2002.
- [20] Haupt RL, Haupt SE. *Practical genetic algorithms*. New York: Wiley Pub, 1998.
- [21] Michalewicz Z. *Genetic algorithms + data structures = evolution programs*. Berlin: St. Martin Paperbacks, 1996.
- [22] K. Pelkmans, J. A. K. Suykens, T. V. Gestel, J. De Brabanter, L. Lukas, B. Hamers, B. De Moor, and J. Vandewalle, "LS-SVMlab: A Matlab/C Toolbox for Least Squares Support Vector Machines," ESAT-SISTA, K. U. Leuven, Leuven, Belgium 2002.
- [23] www.ee.washington.edu/research/pstca/pf14/pg_tca14bus.htm

TABLE V
ANALYSIS OF TRANSMISSION LOSS ALLOCATION FOR IEEE 14-BUS SYSTEM ON HOURS 12

Line		GA-SVM					Total	PSM					Total	Loss from
		G1	G2	G3	G4	G5		G1	G2	G3	G4	G5		Loadflow
1	2	4.1657	0	0	0	0	4.1657	4.1644	0	0	0	0	4.1644	4.1644
1	7	5.1787	0	0	0	0	5.1787	5.175	0	0	0	0	5.175	5.175
2	3	0.4883	0.3665	0	0	0	0.8548	0.4889	0.3667	0	0	0	0.8556	0.8556
2	6	2.352	1.7644	0	0	0	4.1164	2.3503	1.7627	0	0	0	4.113	4.113
2	7	1.8374	1.3784	0	0	0	3.2158	1.8357	1.3767	0	0	0	3.2124	3.2124
3	6	0.1964	0.1474	0.6188	0	0	0.9626	0.1961	0.1471	0.6172	0	0	0.9604	0.9603
7	6	0.1983	0.0453	0	0	0	0.2436	0.1985	0.0453	0	0	0	0.2438	0.2438
6	8	0	0	0	0	0	0	0	0	0	0	0	0	0
6	9	0	0	0	0	0	0	0	0	0	0	0	0	0
7	4	0	0	0	0	0	0	0	0	0	0	0	0	0
4	11	0.4639	0.1059	0	0.3459	0	0.9157	0.4636	0.1058	0	0.3465	0	0.9159	0.9159
4	12	0.605	0.1381	0	0.4514	0	1.1945	0.6046	0.138	0	0.4519	0	1.1945	1.1944
4	13	1.1624	0.2653	0	0.8672	0	2.2949	1.16	0.2647	0	0.8669	0	2.2916	2.2916
5	8	0	0	0	0	0	0	0	0	0	0	0	0	0
8	9	0	0	0	0	0	0	0	0	0	0	0	0	0
9	10	0.1564	0.086	0.0421	0	0.1262	0.4107	0.1561	0.0858	0.0419	0	0.1258	0.4096	0.4096
9	14	0.6317	0.3475	0.1702	0	0.5097	1.6591	0.6307	0.3467	0.1694	0	0.5081	1.6549	1.655
10	11	0.0047	0.0023	0.001	0.0007	0.0029	0.0116	0.0044	0.0024	0.0012	0	0.0036	0.0116	0.0116
13	12	0.0159	0.0036	0	0.0118	0	0.0313	0.016	0.0036	0	0.0119	0	0.0315	0.0316
13	14	0.1965	0.0448	0	0.1466	0	0.3879	0.1968	0.0449	0	0.1471	0	0.3888	0.3888

BIOGRAPHIES

Mohd Wazir Mustafa received his B. Eng. Degree (1988), M. Sc. (1993) and PhD (1997) from University of Strathclyde. He is currently an Associate Professor and Head of Department of Power Engineering at Faculty of Electrical Engineering, Universiti Teknologi Malaysia. He is a member of Institution of Engineers, Malaysia (IEM) and a member of IEEE. His research interest includes power system stability, FACTS, wireless power transmission and power system distribution automation.

Mohd Herwan Sulaiman obtained his B. Eng. (Hons) in Electrical-Electronics and M. Eng. (Electrical-Power) from Universiti Teknologi Malaysia in 2002 and 2007 respectively. From June 2002 to June 2005, he held a position as design engineer at RND department of Panasonic AVC Networks Johor Malaysia Sdn. Bhd. He is currently a lecturer at School of Electrical System Engineering, University Malaysia Perlis (UniMAP), Perlis, Malaysia and PhD student in UTM. His research interests are power system deregulation/ optimization and application of AI to power system studies.

Hussain Shareef received his B. Sc with honours from IIT, Bangladesh, MS Degree from METU, Turkey and PhD degrees from UTM, Malaysia in 1999, 2002 and 2007 respectively. His current interests are power system deregulation, power quality and power system distribution automation. He is currently a Senior Lecturer at Faculty of Electrical Engineering and Build Environment, Universiti Kebangsaan Malaysia.

Saiful Nizam Abd. Khalid received his BEE (1998), MEE (2000) and PhD (2009) degrees from Universiti Teknologi Malaysia. His current research interests are power system deregulation, application of artificial neural network in power system and power tracing.