

STANDARDISATION OF PARTIAL STRENGTH CONNECTIONS OF FLUSH END-PLATE CONNECTIONS FOR TRAPEZOID WEB PROFILED STEEL SECTIONS

Mahmood Md. Tahir¹, Arizu Sulaiman², Shahrin Mohammad¹ and Anis Saggaff²

¹Assoc Professor, Steel Technology Centre,

²PhD Student, Steel Technology Centre, Faculty of Civil Engineering, Universiti Teknologi Malaysia,

81310 UTM Skudai, Johor, Malaysia

E-mail: mahmood@fka.utm.my

ABSTRACT

Connections are usually designed as pinned or rigid although the actual behaviour is known to fall between these two extreme cases. The use of partial strength or semi-rigid connections has been encouraged by codes. Studies on the matter known as semi-continuous construction have proven that substantial savings in steel weight of the overall construction can be achieved. The objective of this paper is to develop a series of standardised partial strength connections tables of flush end-plate connections for trapezoidal web profiled steel (TWP) sections. The range of standard connections presented in tabulated form is limited to six tables comprised of different geometrical aspects of the connections. These tables could enhance the design of semi-continuous construction of multi-storey braced steel frames. The connections are presented in the form of standardised tables which include moment capacity and shear capacity after considering all possible failure modes. The moment capacity, shear capacity, geometrical aspects of the connections, the size of beams, and columns that are suitable with the connections are included in the standardised tables. A method proposed by Steel Construction Institute (SCI) which take into account the requirements in Eurocode 3 and BS 5950:2000 Part 1 were adopted to predict the moment capacity and shear capacity in developing the tables. This proposed method has been successfully applied to the establishment of standardised connections tables for hot-rolled British sections. Although the use of the proposed method is intended for hot rolled section, it is also possible to apply the same proposed method to TWP section provided that the predicted failure modes should comply with the requirements of Eurocode 3 and BS 5950:2000 Part 1 and the TWP section should at least classified as compact section. The moment capacity and shear capacity in the standard tables presented in this paper showed good agreement with the requirement of Eurocode 3 and BS 5950:2000 Part 1.

Keywords : Beam-to-column Connection, Moment Capacity, Partial Strength or Semi-rigid Connection, Semi-Continuous Construction, Trapezoid Web Profiled Section

1.0 INTRODUCTION

Conventionally, steel frames are designed either as pinned jointed or rigidly jointed. When designed as pinned jointed, the beams are assumed as simple supported and the columns are assumed to sustain axial and nominal moment (moment from the eccentricities of beam's end reactions) only. The connection is simple but the sizes of the beams obtained from this approach result in heavy and deep beam. On the other hand, rigidly jointed frame results in heavy columns due to the end moments transmitted through the connection. Hence, a more complicated fabrication of the connection could not be avoided.

One approach, which creates a balance between the two extreme approaches mentioned above, has been introduced. This approach, termed as semi-rigid or partial strength is usually associated with a connection having a moment capacity less than the moment capacity of the connected beam [1]. Partial strength connection is the term used for connection in the design of semi-continuous construction for multi-storey steel frames by Eurocode 3 [2]. In semi-continuous frame the degree of continuity between the beams and columns is greater than that in simple construction design but less than that in continuous construction design. The degree of continuity in the use of partial strength connection of beam to column can be

predicted to produce an economical beam section representing the section between pin joint and rigid joints. By adopting this approach, studies conducted on the use of partial strength connection have proven substantial savings in overall steel weight [3; 4]. This is possible as the use of partial strength has contributed to the benefits at both the ultimate and serviceability limit states design. However, the use of partial strength connections for Trapezoidal Web Profiled (TWP) sections has not been established yet. To establish the study of the use of TWP sections with partial strength connection, standardised partial strength connections tables need to be established first. Therefore, this paper intends to establish the standardised tables for partial strength connections for TWP sections based on the proposed method by SCI.

2.0 WHAT IS TWP SECTION?

A trapezoid web profile plate girder is a built-up section made up of two flanges connected together by a thin corrugated web as shown in Figure 1 [5; 6]. The web and the flanges comprised of different steel grade depending on design requirements. TWP section is also classified as a prefabricated steel section as the section is comprised of two different types of steel grade. The steel grade of the flanges is designed for

S355 and the steel grade of the web is designed for S275. The steel grade of the flanges is purposely designed for S355 so that the flexural capacity of the beam can be increased. The steel grade of the web is designed for S275 so as to reduce the cost of steel material and the capacity of shear is not that critical in the design of the beam [6].

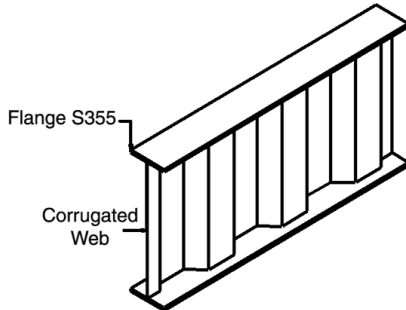

Figure 1: Configuration of Trapezoidal Web Profiled Section

The use of different steel grades in the fabrication of TWP section leads to further economic contribution to steel frames design besides the use of partial strength connection. The use of thick flanges, thin web and deeper beam for TWP section compared with hot-rolled section of the same steel weight leading to heavier load capacity and greater beam span than can be achieved.

A. Advantages of TWP section

The advantages of TWP beam as compared to the conventional plate girder or hot rolled steel section include the following [7]:-

- Utilisation of very thin web which is light weight and reduce the tonnage of the steel.
- Elimination of the need of stiffeners which reduced the fabrication cost.
- The use of high strength steel S355 for flanges and deep beam which lead to higher flexural capacity, wider span and less deflection.

Based on the configuration of the structure, TWP beam can offer substantial saving in the steel usage, and in some cases of up to 40% as compared to conventional rolled sections [5; 6]. It is more significant when there is a need for a column free, long span structural system, such as portal frames for warehouse and factory, girder for bridges, floor and roof beam for high-rise buildings.

3.0 STANDARDISED PARTIAL STRENGTH CONNECTIONS

In the design of braced multi-storey steel frames, the steel weight of the connections may account for less than 5% of the frame weight[1]. However, the cost of the fabrication is in the range of 30% to 50% of the total cost[1]. The increase in the fabrication of the connections is due to the difficulty in selecting the type of connection, the grades and sizes of fittings, bolt grades and sizes, weld types and sizes, and the geometrical aspects. Therefore, a standardized partial strength connections tables are introduced to cater for the problems arise due to so many uncertainties in the fabrication of the connections.

A. Advantages of standardised partial strength connections

The advantages of the partial strength approach are that it utilises the moment resistance of connections to reduce beam depth and weight, while avoiding the use of stiffening in the joints. This practice will reduce the cost of fabrication and ease the erection of steel member in the construction of multi-storey steel frames[1]. The potential benefits of using this approach can be listed as follows [8; 9]:

A.1 Lighter beams

In the design of semi-continuous braced steel frame, the required beam plastic modulus is less than those required in simple frame for the same frame. This reduction is possible as the partial strength connection reduced the design moment of the beam due to the partial restraint effect of the connection as illustrated in Figure 2[4]. The design moment which a beam must resist, decreases as the moment capacity of the connection increases. As a result, a lighter beam can be selected for the design of the beam.

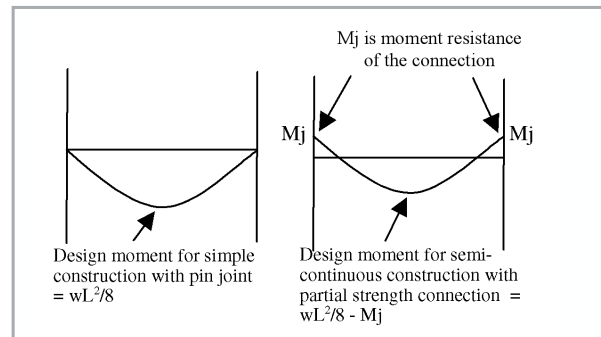

Figure 2: Design moment for beams due to different support conditions

A.2 Shallower beams

The partial restraint of the connection will also result in shallower beams. This is due to the increase in stiffness of the connection, which contributes to the decrease in deflection. The use of partial strength connection will reduce the constant coefficient β in the formulae of deflection ($\beta wL^4/384EI$) in simple construction with uniform load, from β equal to 2 for internal beam, and 3 for external beam[4]. The partial strength connection acts as restrained to the deformation of the beam due to applied load. As a result, a reduction in the deflection of the beam can be achieved which lead to the shallower beam. The relationship

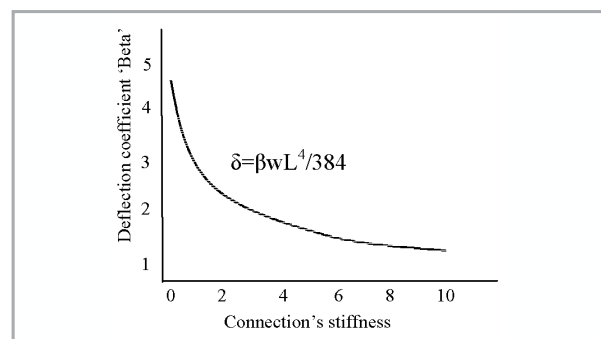

Figure 3: Deflection coefficient 'Beta' as a function of relative stiffness of connection

between connection stiffness and deflection coefficient "Beta" for uniform load on beam is shown in Figure 3[4].

A.3 Greater stiffness and more robust structure

Connection rotational stiffness means that the ends of a beam are restrained against rotation. Partial strength connection has higher capacity to restrain against rotation, shear, moment and tying force compared to pin connection. The rotation capacity should be in the range of 0.02 to 0.03 radians at failure for the connection to be considered as ductile and stiff enough to be categorized as partial strength[1]. The shear capacity of the connection is designed in such a way that the capacity is higher than the shear capacity of the connected beam, and the moment capacity of the connection can resist up to 50% of the moment capacity of the connected beam (M_{cx}) depending on the size and number of bolts for the proposed standard tables[1]. The tying force of the connection is two to three times greater than the tying force required by BS 5950:2000-Part 1 that is 75kN[10]. Therefore, the connection can be categorised as strong, stiff, and robust.

A.4 Lower overall cost

Good connection should be the one which can ease the design process, the preparation of detailing, the fabrication process, and the erection works. It should be also the most cost effective, compared to other types of connection. The saving in the overall cost can be achieved due to the following reasons [9]:-

- A reduction in the number of connection types may lead to a better understanding of the cost and type of connection by all steel players such as fabricator, designer, and erector.
- A standardised connection can enhance the development of design procedures and encourage in the development of computer software.
- The use of limited standardised end-plates or fittings can improve the availability of the material leading to reduction in material cost. At the same time, it will improve the order procedures, storage problems and handling time.
- The use of standardised bolts will reduce the time of changing drills or punching holes in the shop which lead to faster erection and less error on site. The drilling and welding process can be carried out at shop, as the geometrical aspects of the connection have already been set. This leads to fast and quality fabrication.

Although the advantages or benefits of using the partial strength connections are quite significant, the disadvantages of this approach should also be addressed. The disadvantage in this approach is that it may be marginally more expensive to fabricate partial-strength connection rather than simple connections. However, the benefit of overall cost saving of the partial strength connections have proven to be more than simple connection [3; 4]. It is reported that the savings in steel weight of using partial strength connection in multi-storey braced steel frames using British hot-rolled section was up to 12%[3]. The overall cost saving was up to 10% of the construction cost which is quite significant[3].

B. Range of standard flush end-plate connections

The use of partial strength connection for hot-rolled British sections has well established by SCI[1]. A series of tests at the

University of Abertay, Dundee has been successfully been carried out to verify the predicted moment and shear capacity with the experimental tests capacities[11]. The results confirmed with the predicted values and the standardised tables for the connection have been published by SCI[1]. In the development of standard flush end-plate connections tables for TWP sections, only six tables are presented in this study based on the proposed method. Although the best validation of the results presented in the tables is by comparing the predicted results with the actual experimental tests results, however, the presented standard connection tables for TWP section can still be use by adopting the same failure modes of the hot-rolled section as tested by SCI. A few tests have been carried out to support the predicted moment resistance of the connection using TWP section as a beam. Some of the results are presented later in this paper. The proposed standard connections have the following attributes which in some cases the attributes are not exactly the same as the one described by SCI in hot-rolled section.

- 12mm thick end plates in conjunction with the use of M20 bolts.
- 15mm thick end plates in conjunction with the use of M24 bolts.
- Strength of end plates was maintained as S275 steel.
- Width of the end plate was kept at 200mm and 250mm with the vertical height of the end-plate was kept at the beam depth plus 50mm.
- Full strength of flange welds with size of weld proposed at 10mm
- Full strength of web welds with size of weld proposed at 8mm
- The vertical and horizontal distance between the bolts was maintained at 90mm.

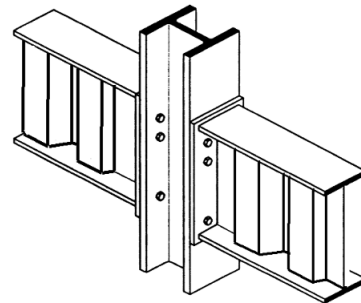

Figure 4: Typical flush end-plate connection of TWP beam section connected to British hot-rolled section

Figure 4, shows a typical flush end plate connection for TWP section as beam connected to British hot-rolled section as column. British section is selected for the column as it is very good in compression which is not the case for TWP section as the web of TWP is too thin to carry axial load. TWP section is proposed for beam as the corrugated web section is very effective to cater for buckling and bearing resistance. The minimum thickness for corrugated web is 3mm for shallow beam and the maximum thickness is 6mm for deeper beam. The ratio of beam depth versus web thickness is kept not to exceed the limit for compact section as described by BS5950:2000 Part 1 [10].

4.0 PROPOSED METHOD APPLIED TO THE DEVELOPMENT OF THE STANDARD TABLES

Unlike simple and rigid connections, the design of partial strength connections involves more complex and rigorous procedures. Therefore, Steel Construction Institute published a reference guide in designing moment connections, which includes sections on the standardised capacity tables for bolted end plate connections[1]. The design model presented in the SCI's guide is in accordance to the procedures in Annex J of EC3[2], which is based on the plastic distribution of bolt forces. Traditionally, the bolt forces are taken as a triangular distribution but plastic distribution is 'accurately' representing the actual behavior of bolt forces as shown in Figure 5. In the SCI's guide[1], the beam-to-column arrangements constitute of conventional hot rolled sections for both the beams and the columns. In this study, TWP sections is used as beams. Therefore, the tables provided in the design guide for hot rolled British sections are not applicable to the TWP sections as the section properties of TWP sections are not similar.

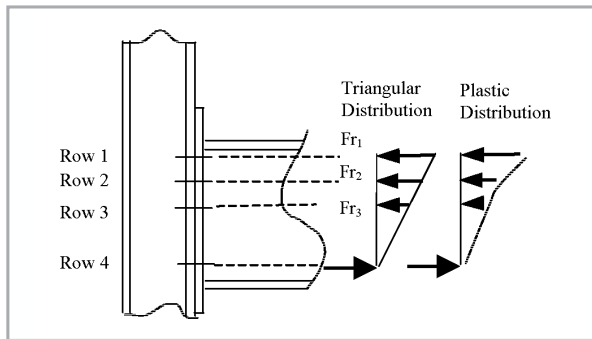

Figure 5: Forces in connection and corresponding distribution

A. Design philosophy of the connections

The design model adopted in this study is actually presented in Annex J of Eurocode 3: Part 1.1[2]. For checking the details of strength on the bolts, welds, and steel section, modification to suit BS 5950:2000 Part 1 have been made[10]. The checking on the capacity of the connections is classified into three zones namely tension zone, compression zone, and shear zone as shown in Fig. 6[1]. The basic principles of the distribution of bolt forces need to be addressed first before details of the checking on all possible modes of failures can be discussed.

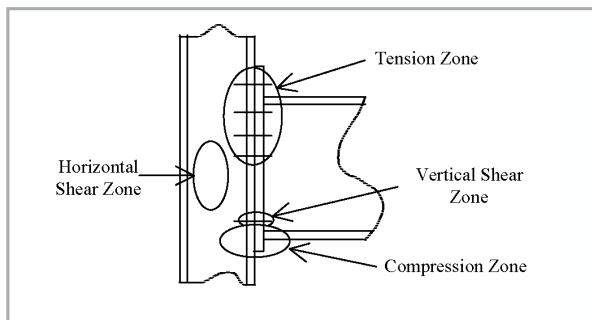

Figure 6: Critical zones that need to be checked for failure

A.1 Distribution of bolt forces

The moment resistance of a connection transmitted by an end plate connection is through the coupling action between the

tension forces in bolts and compression force at the centre of the bottom flange. Each bolt above the neutral axis of the beam produced tension force whereas the bolts below the neutral axis are dedicated to shear resistance only. Eurocode 3 suggests that the bolt forces distribution should be based on the plastic distribution instead of the traditional triangular distribution[2]. Figure 5 shows the distribution of bolt forces under negative moment. The forces of the bolt are based on the plastic distribution which is the actual value of bolt-row resistance calculated from the critical zones, as shown in Figure 6. The force from the bolt rows above the neutral axis transmits to the end-plate connection as tension force which balanced up by the compression force at the bottom flange of the beam to the column. The end-plate is connected to the beam web and both of the flanges by welding. The formation of tension at the top and compression at the bottom contributes to the development of moment resistance of the connection. Tests on the connections have showed that the centre of compression flange which bears against the column was found to be the centre of rotation of the connection[11]. The force permitted in any bolt row is based on its potential resistance and not just the length of the lever arm.

A.2 Tension zone

The resistance at each bolt row in the tension zone may be limited due to bending of column flange, end-plate, column web, beam web, and bolt strength. Column flange or end-plate bending was checked by using Eurocode 3 which converts the complex pattern of yield lines around the bolts into a simple 'equivalent tee-stub'. Details of the procedures are illustrated in SCI publication[1].

A.3 Compression zone

The checking in the compression zone are the same procedures as mention in BS 5950:2000 Part 1 which requires checks on web bearing and web buckling. The compression failure modes can be on the column side or on the beam side. The column side should be checked for web buckling and web bearing due to the compression force applied to the column. The use of stiffener or the effect of having other beam connected to the web of the column is not included so as to reduce the cost of fabrication and simplified the calculation. The compression on the beam side can usually be regarded as being carried entirely by the beam flange, however when large moments combine with axial load, the compression zone will spread to the web of the beam which will effect the centre of compression. Therefore, the stiffening of the web of the beam needs to be done. However, in this study the moment resistance of the connection is not considering the use of stiffener in order to reduce the cost of fabrication.

A.4 Shear zone

The column web can fails due to the shearing effect of the tension and compression force applied to the web of the column. The failure to the shearing of the web is most likely to happen before it fails due to bearing or buckling. This is possible because the thickness of the flange is more than the thickness of the web. Again in this shear zone, stiffer is not needed so as to reduce the cost of fabrication.

A.5 Welding

Fillet weld is preferred than the butt welds as the welding of beam to the end-plate is positioned at 90 degree which is

suitable for fillet weld to be used. The end-plate is connected to the web of the beam by 8mm fillet weld and 10mm fillet weld is suggested for the end-plate connected to the flange. The weld is designed in such a way that the failure mode of the connection is not on the welding. This is to ensure the ductility of the connection which is necessary for partial strength connection.

B. Validation of the standardized connections tables

The validation of the standardized connections tables for TWP is best presented by comparing the predicted values in the table with full scale testing of the connections. Therefore, a series of full scale testing on TWP girder sections comprised of four specimens was conducted by the Steel Technology Centre, Universiti Teknologi Malaysia. Although the tests did not cover the whole ranged of the proposed connections, the comparison of the tests and the predicted values can still be established.

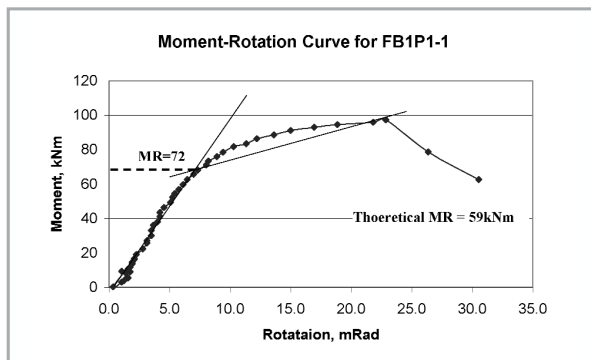

Figure 7(a): Moment-rotation curve for the experiment for specimen FB1P1-1

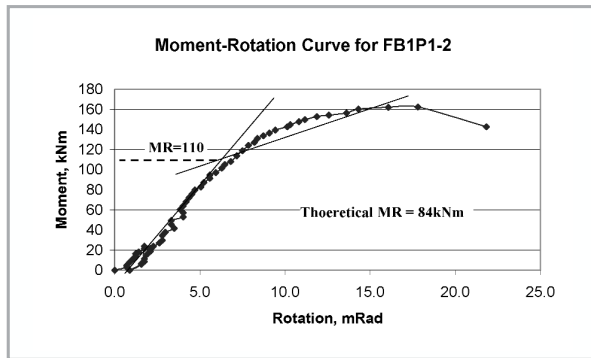

Figure 7(b): Moment-rotation curve for the experiment for specimen FB1P1-2

Figures 7 (a and b) showed some of the results of the experiment by plotting the moment-rotation curves of the connection. The test results showed good agreement with the predicted values. The failure modes of end-plate of the connections are shown in Fig 8 as expected from the calculation. Details of the method of testing and the discussion of the result have been published in technical report by Steel Technology Centre[12].

5.0 EXPLANATION ON THE NOTATION USED IN THE PROPOSED CAPACITY TABLES

Six configurations of flush end plate connections tables have been developed as shown in Table 1. A computer programming based on spread sheet has been developed to calculate and

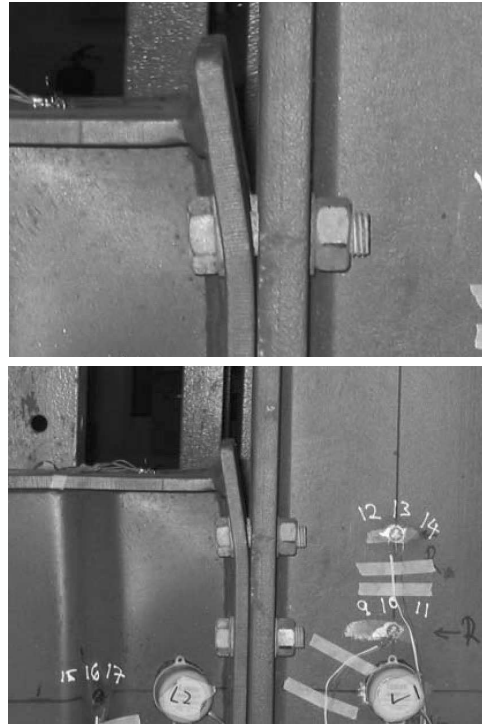

Figure 8: Failure modes of flush end-plate connection during test

predict the moment capacity and shear capacity of the standardised connections proposed in Table 1 based on the critical zones checks and method proposed by SCI as described earlier. The details of the capacities of the standard tables for the connections are tabulated in Tables 2 to 7. The moment capacity from the proposed table is calculated from the summation of each bolt row multiply by the lever arm of the connection. The lever arm for the first tension bolt row, which is defined as 'dimension A' measured from the centre of compression capacity to the lowest bolt-row in tension. The lever arm for the second tension bolt row is measured as 'dimension A' plus the distance of the first tension bolt row to the second tension bolt row, in this case 90mm. All flange welds are to be fully welded with minimum fillet weld of size 10mm for flange and 8mm for web. A tick in the table indicates that the column flange and web in tensions have a greater capacity than the beam force as indicated in the figure of the beam-side table. If the column has a smaller capacity, the reduction of bolt force is shown in the table. A modified moment resistance is has been reduced can be determined from this lower forces. A tick in compression zone indicates that the column web has a greater compression capacity than the sum of the bolt row forces. A vertical shear capacity is the shear resistance of the bolt due to shearing, bearing to the bolt and bearing to the plate.

Table 1: Configurations of end plate connections used to generate standardised tables

Type of Connections	Row of Bolts	Type of Bolts	Size of End Plates	Design Grade
Flush EP	1	M20 8.8	200 x 12	43
Flush EP	2	M20 8.8	200 x 12	43
Flush EP	2	M20 8.8	250 x 12	43
Flush EP	1	M24 8.8	200 x 15	43
Flush EP	2	M24 8.8	200 x 15	43
Flush EP	2	M24 8.8	250 x 15	43

6.0 DISCUSSION OF RESULTS

The standard tables as shown in Tables 2 to 7 illustrate the geometrical configuration of the suggested connections and the capacities of the connections. The suggested size of column and beam used for the proposed connection is listed in the designated

table. The moment capacity of the connection is listed base on the size of the beam. The smallest suggested size of beam is taken as 300x120. The TWP section is not economical to produce beam smaller than 300x120. The largest suggested size of beam is taken as 650x250. Although TWP section can be

Table 2: Standard table for flush end-plate for 1 row M20 8.8 bolts, 200x12 end-plate (FEP,1BRM20,200W12TEP)

1 ROW M20 8.8 BOLTS				
200 x 12 DESIGN GRADE 43 FLUSH END PLATE				
Beam Side	BEAM – FLANGE S355			
	WEB S275			
	Beam Serial Size	Dimension 'A'		Moment Capacity
	DxBxkg/m (T/t)	(mm)		(kNm)
	300 x 120 x 26.3 (10/3)	235	48	
	300 x 140 x 33.7 (12/3)	234	49	
	350 x 120 x 27.6 (10/3)	285	59	
	350 x 140 x 35.1 (12/3)	284	59	
	400 x 140 x 39.7 (12/4)	334	69	
	400 x 160 x 48.4 (14/4)	333	69	
	450 x 160 x 50.2 (14/4)	383	79	
	450 x 180 x 60.1 (16/4)	382	79	
	500 x 160 x 52.0 (14/4)	433	90	
	500 x 180 x 61.9 (16/4)	432	90	
	550 x 200 x 73.3 (16/5)	482	100	
	600 x 200 x 80.5 (16/6)	532	110	

Column Side	DESIGN GRADE S275			COLUMN		DESIGN GRADE S355		
	Panel Shear Capacity (kN)	Tension Zone	Compn Zone	Serial Size	Compn. Zone	Tension Zone	Panel Shear Capacity (kN)	
		F_{R1} (kN)				F_{R1} (kN)		
	1000	√	√	356 x 368 x 202	√	√	1302	
	849	√	√	177	√	√	1105	
	725	√	√	153	√	√	944	
	605	√	√	129	√	√	787	
	1037	√	√	305 x 305 x 198	√	√	1350	
	816	√	√	158	√	√	1062	
	703	√	√	305 x 305 x 137	√	√	915	
	595	√	√	118	√	√	774	
	503	√	√	97	√	√	649	
	882	√	√	254 x 254 x 167	√	√	1149	
	685	√	√	132	√	√	892	
	551	√	√	107	√	√	717	
	434	√	√	89	√	√	566	
	360	√	√	73	√	√	465	
	459	√	√	203 x 203 x 86	√	√	598	
	353	√	√	71	√	√	460	
	322	√	√	60	√	√	415	
	272	√	√	52	√	√	351	
	245	198	√	46	√	√	316	

Tension Zone:
 √ Column satisfactory for bolt row tension values shown for the beam side.
 xxx Calculate reduced moment capacity using the reduced bolt row values.

Compression Zone:
 √ Column capacity exceeds ΣF_v .
 S (xxx) Column requires stiffening to resist ΣF_v (value is the column web capacity).

produced for up to 1600mm deep, the limited suggested size for partial strength connection is up to 650mm deep. This is to maintain the ductility of the connection that is crucial for partial strength connection. The shear capacity of the connection is based on the shear capacity of the tension bolt row and lower bolt rows. However, the lower bolt row will carry most of the shear force. The increase in moment capacity depends on the size of bolt, the number of bolt, the size of end-plate, and the thickness of end-plate. The notation used for the designated connection such as (FEP,1BRM20,200W12TEP) meaning that the connection is flush end-plate with one bolt row of M20 grade 8.8, and end-plate size of 200mm wide and 12mm thick. The comparison of the moment capacity of the connection based on different geometrical configuration of the connections is discussed below:-

A. Effect of increasing the number of bolt row from one row to two rows. (FEP,1BRM20,200W12TEP) versus (FEP,2BRM20,200W12TEP) and (FEP,1BRM24,200W15TEP) versus (FEP,2BRM24,200W15TEP)

Tables 2 and 3 show the moment capacity of the connection for single bolt row. Tables 4 and 5 show the moment capacity of the connection for double bolt rows. The results of percentage increase in moment capacity for one and two bolt rows are showed in Table 8. The results showed that by increasing the number of bolt row from one to two, moment capacity of the connection is increased by an average about 50% for M20 bolt with 12mm thick end-plate and an average of 59% for M24 bolt with 15mm thick end-plate. The combination of M24 with 15mm thick end-plate has contributed to the increase in the moment capacity of the connection. The increment however is not that significant. The increase in moment capacity is very much linear to the depth of the beam. This shows that the moment capacity of the connection depends on the depth of the beam, the number and size of bolt, and the thickness of the end-plate.

The vertical shear capacity of connection in Table 2 is increased from 258kN without optional shear bolt row to 442kN with shear bolt row. The increment of the vertical shear capacity is not exactly double as the determination of the shear capacity depends on the number of row of the tension bolt too. The vertical shear capacity of the connection in Table 4 is 515kN with optional shear bolt row. This value is twice the vertical shear capacity of the connection in Table 2 without optional shear bolt row. This is because the number of bolt row at the tension zone in Table 4 is two rows. Panel shear capacity for connection in Table 2 and Table 4 is the same as the size of the columns is the same and the force of tension and compression that exert on the column web is not high enough to change the calculated values.

B. Effect of increasing the size of end-plate from 200mm to 250mm (FEP,2 BRM20,200W12TEP) versus (FEP,2BRM20,250W12TEP) and (FEP,2BRM24,200W15TEP) versus (FEP,2BRM24,250W15TEP)

Tables 4 and 6 show the moment capacity of the connection for end-plate width of 200mm. Table 5 and 7 show the moment capacity of the connection for end-plate width of 250mm. The idea of comparison is to know the percentage increase due to increment of the width of the end-plate. The results of percentage increase in moment capacity for 200mm and 250mm wide of the

end-plate are tabulated in Table 9. The results showed that by increasing the size of end-plate width from 200mm to 250mm, moment capacity of the connection is increased by an average about 5.1% for M20 bolt with 12mm thick end-plate and an average of 2.7% for M24 bolt with 15mm thick end-plate. The results show that the increment of the plate size from 200 to 250mm has contributed to a marginal amount of moment capacity to the connection. For M24 bolt, the increment in moment capacity is reduced by almost half of M20 bolt. This shows that the moment capacity of the connection depends on the strength of the bolt more than the strength of the end-plate.

C. Effect of increasing the size of bolt from M20 with 12mm thick end-plate to M24 with 15mm thick end-plate (FEP,1 BRM20,200W12TEP) versus (FEP,1BRM24,200W15TEP) and (FEP,2BRM20,200W12TEP) versus (FEP,2BRM24,200W15TEP)

The need to compare the result is to know the percentage increase due to increment of the size of bolt and thickness of the end-plate. The results of percentage increase in moment capacity for M20 with 12mm thick end-plate and M24 with 15mm thick end-plate are tabulated in Table 10. The results showed that by increasing the size of bolt from M20 with 12mm thick end-plate to M24 with 15mm thick end-plate, the moment capacity of the connection is increased by an average about 48% for one bolt row and 55% for two bolt rows. The result show that the moment capacity of the connection depends on the strength of the bolt more than the strength of the end-plate.

7.0 CONCLUSIONS

This study concluded that it is possible to determine the moment capacity of flush end plate connections connected to a column flange by adopting the method proposed by SCI, even for different geometric parameters such as TWP section. The capacities of the connection depend on the geometrical aspects of the connection such as the size of bolt, number of bolt, size of end-plate, thickness of end-plate, size of beam and size of column. For the size of column, the reduction of moment capacity is due to the effect of compression of the beam flange to the column flange without the need of stiffener. The suggested weld size for flange and web is strong enough to prevent any failure at the weld. The increment of moment capacity of the connection can be concluded as follows:-

- The increase in the number of bolt row from one row to two rows has contributed to an increase in the moment capacity in the range of 50% to 59% which is quite significant.
- The increase in the size of end-plate from 200mm to 250mm has contributed to an increase in the moment capacity in the range of 2.7% to 5.1% which is not significant.
- The increase the size of bolt from M20 with 12mm thick end-plate to M24 with 15mm thick end-plate has contributed to an increase in the moment capacity in the range of 48% to 55% which is about the same as the effect of increasing the number of bolt from one to two bolt rows.
- The shear capacity of the connection depends on number of bolt used in the connection. However, the lower bolt row contributed to most of the shear capacity of the connection by an increment of 71% with the addition of optional shear bolt row.
- The proposed tables can be used in the design of semi-continuous construction in multi-storey steel frames.

ACKNOWLEDGEMENT

This study is part of a research towards a PhD by one of the authors. The authors would like to acknowledge special thanks and gratitude to CIDB for funding this project under Vot 73049.

Special thanks also to the research assistants that involved in this project namely Tan Cher Siang, Thong Chin Mun, and Ong Shih Liang, who have contributed to the work in this project. ■

Table 3: Standard table for flush end-plate for 1 row M24 8.8 bolts, 200x15 end-plate (FEP,1BRM24,200W1STEP)

1 ROW M24 8.8 BOLTS				
200 x 15 DESIGN GRADE 43 FLUSH END PLATE				
Beam Side	BEAM – FLANGE S355			
	WEB S275			
	Beam Serial Size	Dimension 'A' (mm)		Moment Capacity (kNm)
	DxBxkg/m (T/t)			
	300 x 120 x 26.3 (10/3)	235	71	
	300 x 140 x 33.7 (12/3)	234	72	
	350 x 120 x 27.6 (10/3)	285	86	
	350 x 140 x 35.1 (12/3)	284	87	
	400 x 140 x 39.7 (12/4)	334	102	
	400 x 160 x 48.4 (14/4)	333	102	
	450 x 160 x 50.2 (14/4)	383	117	
	450 x 180 x 60.1 (16/4)	382	117	
	500 x 160 x 52.0 (14/4)	433	133	
	500 x 180 x 61.9 (16/4)	432	132	
	550 x 200 x 73.3 (16/5)	482	148	
	600 x 200 x 80.5 (16/6)	532	163	

Column Side	DESIGN GRADE S275			COLUMN	DESIGN GRADE S355			
	Panel Shear Capacity (kN)	Tension Zone	Compn. Zone		Serial Size	Compn. Zone	Tension Zone	Panel Shear Capacity (kN)
		F_{R1} (kN)					F_{R1} (kN)	
	1000	√	√	356 x 368 x 202	√	√	1302	
	849	√	√	177	√	√	1105	
	725	√	√	153	√	√	944	
	605	√	√	129	√	√	787	
	1037	√	√	305 x 305 x 198	√	√	1350	
	816	√	√	158	√	√	1062	
	703	√	√	305 x 305 x 137	√	√	915	
	595	√	√	118	√	√	774	
	503	√	√	97	√	√	649	
	882	√	√	254 x 254 x 167	√	√	1149	
	685	√	√	132	√	√	892	
	551	√	√	107	√	√	717	
	434	√	√	89	√	√	566	
	360	297	√	73	√	√	465	
	459	√	√	203 x 203 x 86	√	√	598	
	353	√	√	71	√	√	460	
	322	297	√	60	√	√	415	
	272	265	√	52	√	296	351	
	245	204	√	46	√	263	316	

Tension Zone:
 √ Column satisfactory for bolt row tension values shown for the beam side.
 xxx Calculate reduced moment capacity using the reduced bolt row values.

Compression Zone:
 √ Column capacity exceeds ΣF_c .
 S (xxx) Column requires stiffening to resist ΣF_c (value is the column web capacity).

Table 4: Standard table for flush end-plate for 2 row M20 8.8 bolts, 200x12 end-plate (FEP,2BRM20,200W12TEP

Beam Side	2 ROWS M20 8.8 BOLTS 200 x 12 DESIGN GRADE 43 FLUSH END PLATE			
	BEAM – FLANGE S355 WEB S275			
	Beam Serial Size	Dimension 'A' (mm)		Moment Capacity (kNm)
	DxBxkg/m (T/t)			
	400 x 140 x 39.7 (12/4)	244	103	
	400 x 160 x 48.4 (14/4)	243	103	
	450 x 160 x 50.2 (14/4)	293	120	
	450 x 180 x 60.1 (16/4)	292	120	
	500 x 160 x 52.0 (14/4)	343	137	
	500 x 180 x 61.9 (16/4)	342	137	
	550 x 200 x 73.3 (16/5)	392	155	
	600 x 200 x 80.5 (16/6)	442	173	
	650 x 250 x 103.4 (18/6)	491	190	

Column Side	DESIGN GRADE S275			COLUMN Serial Size	DESIGN GRADE S355				
	Panel Shear Capacity (kN)	Tension Zone			Compn. Zone	Compn. Zone	Tension Zone		Panel Shear Capacity (kN)
		F _{R1} (kN)	F _{R2} (kN)				F _{R1} (kN)	F _{R2} (kN)	
	1000	√	√	√	356 x 368 x 202	√	√	√	1302
	849	√	√	√	177	√	√	√	1105
	725	√	√	√	153	√	√	√	944
	605	√	√	√	129	√	√	√	787
	1037	√	√	√	305 x 305 x 198	√	√	√	1350
	816	√	√	√	158	√	√	√	1062
	703	√	√	√	137	√	√	√	915
	595	√	√	√	118	√	√	√	774
	503	√	√	√	97	√	√	√	649
	882	√	√	√	254 x 254 x 167	√	√	√	1149
	685	√	√	√	132	√	√	√	892
	551	√	√	√	107	√	√	√	717
	434	√	√	√	89	√	√	√	566
	360	√	√	√	73	√	√	√	465
	459	√	√	√	203 x 203 x 86	√	√	√	598
	353	√	√	√	71	√	√	√	460
	322	√	√	√	60	√	√	√	415
	272	√	√	√	52	√	√	√	351
	245	198	97	√	46	√	√	√	316

Tension Zone:
 √ Column satisfactory for bolt row tension values shown for the beam side.
 xxx Calculate reduced moment capacity using the reduced bolt row values.

Compression Zone:
 √ Column capacity exceeds ΣF_r.
 S (xxx) Column requires stiffening to resist ΣF_r (value is the column web capacity).

STANDARDIZATION OF PARTIAL STRENGTH CONNECTIONS OF FLUSH END-PLATE CONNECTIONS FOR TRAPEZOID WEB PROFILED STEEL SECTIONS

Table 5: Standard table for flush end-plate for 2 row M20 8.8 bolts, 250x12 end-plate (FEP,2BRM20,250W12TEP)

2 ROWS M20 8.8 BOLTS			
250 x 12 DESIGN GRADE 43 FLUSH END PLATE			
Beam Side	BEAM – FLANGE S355		Moment Capacity (kNm)
	WEB S275		
	Beam Serial Size	Dimension 'A' (mm)	
	DxBxkg/m (T/t)	(mm)	
	400 x 140 x 39.7 (12/4)	244	109
	400 x 160 x 48.4 (14/4)	243	109
	450 x 160 x 50.2 (14/4)	293	125
	500 x 160 x 52.0 (14/4)	343	144
	500 x 180 x 61.9 (16/4)	342	143
	550 x 200 x 73.3 (16/5)	392	162
	600 x 200 x 80.5 (16/6)	442	182
	650 x 250 x 103.4 (18/6)	491	200

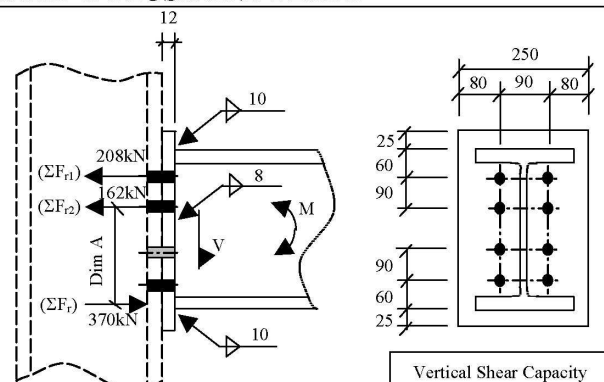

Vertical Shear Capacity
515 kN

Column Side	DESIGN GRADE S275			COLUMN Serial Size	Compn. Zone	DESIGN GRADE S355		Panel Shear Capacity (kN)				
	Panel Shear Capacity (kN)	Tension Zone				Compn. Zone	F _{R1} (kN)		F _{R2} (kN)			
		F _{R1} (kN)	F _{R2} (kN)									
				356 x 368 x	202	√	√	√				
	1000	√	√						√	√	√	1302
	849	√	√						√	√	√	1105
	725	√	√						√	√	√	944
	605	√	√	√	√	√	√	787				
				305 x 305 x	198	√	√	√				
	1037	√	√						√	√	√	1350
	816	√	√						√	√	√	1062
	703	√	√						√	√	√	915
	595	√	√						√	√	√	774
	503	√	√						√	√	√	649
				254 x 254 x	167	√	√	√				
	882	√	√						√	√	√	1149
	685	√	√						√	√	√	892
	551	√	√						√	√	√	717
	434	√	√						√	√	√	566
	360	√	√	√	√	√	465					
				203 x 203 x	86	√	√	√				
	459	√	√						√	√	√	598
	353	√	√						√	√	√	460
	322	√	√						√	√	√	415
	272	√	√						√	√	√	351
	245	198	97						√	√	√	316

Tension Zone:

- √ Column satisfactory for bolt row tension values shown for the beam side.
- xxx Calculate reduced moment capacity using the reduced bolt row values.

Compression Zone:

- √ Column capacity exceeds ΣF_r.
- S (xxx) Column requires stiffening to resist ΣF_r (value is the column web capacity).

Table 6: Standard table for flush end-plate for 2 row M24 8.8 bolts, 200x15 end-plate (FEP,2BRM24,200W12TEP)

Beam Side	2 ROWS M24 8.8 BOLTS 200 x 15 DESIGN GRADE 43 FLUSH END PLATE		
	BEAM – FLANGE S355 WEB S275		
	Beam Serial Size	Dimension 'A' (mm)	Moment Capacity (kNm)
	DxBxkg/m (T/t)		
	350 x 120 x 27.6 (10/3)	195	134
	350 x 140 x 35.1 (12/3)	195	134
	400 x 140 x 39.7 (12/4)	244	160
	400 x 160 x 48.4 (14/4)	243	160
	450 x 160 x 50.2 (14/4)	293	187
	450 x 180 x 60.1 (16/4)	292	187
	500 x 160 x 52.0 (14/4)	343	214
	500 x 180 x 61.9 (16/4)	342	214
	550 x 200 x 73.3 (16/5)	392	241
	600 x 200 x 80.5 (16/6)	442	269
	650 x 250 x 103.4 (18/6)	491	295

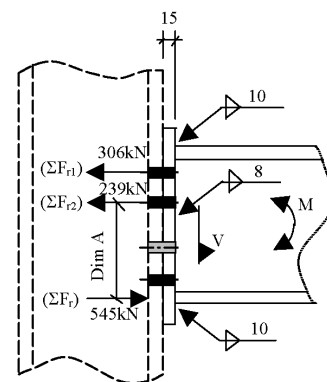
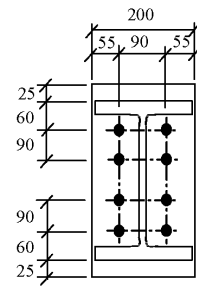
Column Side	DESIGN GRADE S275			COLUMN Serial Size	DESIGN GRADE S355				
	Panel Shear Capacity (kN)	Tension Zone			Compn. Zone	Compn. Zone	Tension Zone		Panel Shear Capacity (kN)
		F _{R1} (kN)	F _{R2} (kN)				F _{R1} (kN)	F _{R2} (kN)	
	1000	√	√	√	356 x 368 x 202	√	√	√	1302
	849	√	√	√	177	√	√	√	1105
	725	√	√	√	153	√	√	√	944
	605	√	√	√	129	√	√	√	787
	1037	√	√	√	305 x 305 x 198	√	√	√	1350
	816	√	√	√	158	√	√	√	1062
	703	√	√	√	137	√	√	√	915
	595	√	√	√	305 x 305 x 118	√	√	√	774
	503	√	√	√	97	√	√	√	649
	882	√	√	√	254 x 254 x 167	√	√	√	1149
	685	√	√	√	132	√	√	√	892
	551	√	√	√	107	√	√	√	717
	434	√	√	√	89	√	√	√	566
	360	297	√	S(484)	73	√	√	√	465
	459	√	√	√	203 x 203 x 86	√	√	√	598
	353	√	√	√	71	√	√	√	460
	322	297	204	S(491)	60	√	√	√	415
	272	265	118	√	52	√	296	198	351
	245	204	90	√	46	√	263	116	316

Tension Zone:
 √ Column satisfactory for bolt row tension values shown for the beam side.
 xxx Calculate reduced moment capacity using the reduced bolt row values.

Compression Zone:
 √ Column capacity exceeds ΣF_r.
 S (xxx) Column requires stiffening to resist ΣF_r (value is the column web capacity).

STANDARDIZATION OF PARTIAL STRENGTH CONNECTIONS OF FLUSH END-PLATE CONNECTIONS FOR TRAPEZOID WEB PROFILED STEEL SECTIONS

Table 7: Standard table for flush end-plate for 2 row M24 8.8 bolts, 250x15 end-plate (FEP,2BRM24,250W15TEP

2 ROWS M24 8.8 BOLTS			
250 x 15 DESIGN GRADE 43 FLUSH END PLATE			
Beam Side	BEAM – FLANGE S355 WEB S275		
	Beam Serial Size	Dimension 'A' (mm)	Moment Capacity (kNm)
	DxBxkg/m (T/t)		
	400 x 140 x 39.7 (12/4)	244	165
	400 x 160 x 48.4 (14/4)	243	165
	450 x 160 x 50.2 (14/4)	293	192
	450 x 180 x 60.1 (16/4)	292	192
	500 x 180 x 61.9 (16/4)	342	220
	500 x 180 x 61.9 (16/4)	342	220
	550 x 200 x 73.3 (16/5)	392	248
	600 x 200 x 80.5 (16/6)	442	276
	650 x 250 x 103.4 (18/6)	491	304

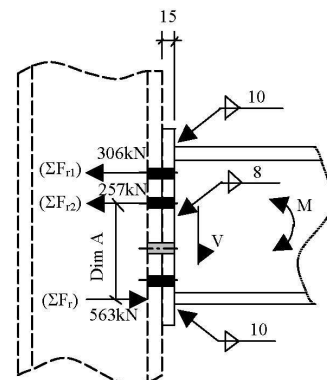
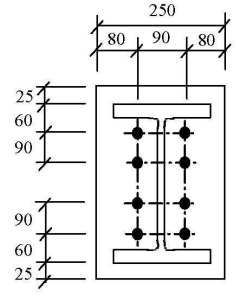
Vertical Shear Capacity
739 kN

Column Side	DESIGN GRADE S275			COLUMN Serial Size	DESIGN GRADE S355					
	Panel Shear Capacity (kN)	Tension Zone			Compn. Zone	Compn. Zone	Tension Zone		Panel Shear Capacity (kN)	
		F _{R1} (kN)	F _{R2} (kN)				F _{R1} (kN)	F _{R2} (kN)		
	1000	√	√	√	356 x 368 x	202	√	√	√	1302
	849	√	√	√		177	√	√	√	1105
	725	√	√	√		153	√	√	√	944
	605	√	√	√		129	√	√	√	787
	1037	√	√	√	305 x 305 x	198	√	√	√	1350
	816	√	√	√		158	√	√	√	1062
	703	√	√	√		137	√	√	√	915
	595	√	√	√	305 x 305 x	118	√	√	√	774
	503	√	√	√		97	√	√	√	649
	882	√	√	√	254 x 254 x	167	√	√	√	1149
	685	√	√	√		132	√	√	√	892
	551	√	√	√		107	√	√	√	717
	434	√	√	√		89	√	√	√	566
	360	297	√	S(479)		73	√	√	√	465
	459	√	√	√	203 x 203 x	86	√	√	√	598
	353	√	√	S(561)		71	√	√	√	460
	322	297	204	S(486)		60	√	√	√	415
	272	265	118	√		52	√	296	198	351
	245	204	90	√		46	√	263	116	316

Tension Zone:
 √ Column satisfactory for bolt row tension values shown for the beam side.
 xxx Calculate reduced moment capacity using the reduced bolt row values.

Compression Zone:
 √ Column capacity exceeds ΣF_r.
 S (xxx) Column requires stiffening to resist ΣF_r (value is the column web capacity).

Table 8: Percentage increase in moment capacity of the connection by increasing the number of bolt row from one bolt to two bolt rows

Size of TWP beam	(FEP,1BRM20,200W12TEP) versus (FEP,2BRM20,200W12TEP)			(FEP,1BRM24,200W15TEP) versus (FEP,2BRM24,200W15TEP)		
	One bolt row	Two bolt rows	% increase	One bolt row	Two bolt rows	% increase
350 x 120 x 27.6 (10/3)	59	86	45.8%	86	134	55.8%
350 x 140 x 35.1 (12/3)	59	87	47.5%	87	134	54.0%
400 x 140 x 39.7 (12/4)	69	103	49.3%	102	160	56.9%
400 x 160 x 48.4 (14/4)	69	103	49.3%	102	160	56.9%
450 x 160 x 50.2 (14/4)	79	120	51.9%	117	187	59.8%
450 x 180 x 60.1 (16/4)	79	120	51.9%	117	187	59.8%
500 x 160 x 52.0 (14/4)	90	137	52.2%	133	214	60.9%
500 x 180 x 61.9 (16/4)	90	137	52.2%	132	214	62.1%
550 x 200 x 73.3 (16/5)	100	155	55.0%	148	241	62.3%
600 x 200 x 80.5 (16/6)	110	173	57.3%	163	268	64.4%

Table 9: Percentage increase in moment capacity of the connection by increasing the size of end-plate from 200mm to 250mm wide

Size of TWP beam	(FEP,2BRM20,200W12TEP) versus (FEP,2BRM20,250W12TEP)			(FEP,2BRM24,200W15TEP) versus (FEP,2BRM24,250W15TEP)		
	250mm	200mm	% increase	250mm	200mm	% increase
400 x 140 x 39.7 (12/4)	109	103	5.8%	164	160	2.5%
400 x 160 x 48.4 (14/4)	109	103	5.8%	164	160	2.5%
450 x 160 x 50.2 (14/4)	125	120	4.2%	192	187	2.7%
450 x 180 x 60.1 (16/4)	125	120	4.2%	192	187	2.7%
500 x 160 x 52.0 (14/4)	144	137	5.1%	220	214	2.8%
500 x 180 x 61.9 (16/4)	143	137	5.8%	220	214	2.8%
550 x 200 x 73.3 (16/5)	162	155	4.5%	248	241	2.9%
600 x 200 x 80.5 (16/6)	182	173	5.2%	276	268	2.9%

Table 10: Percentage increase in moment capacity of the connection by increasing the size of bolt and thickness of end-plate

Size of TWP beam	(FEP,1 BRM20,200W12TEP) versus (FEP,1BRM24,200W15TEP)			(FEP,2BRM20,200W12TEP) versus (FEP,2BRM24,200W15TEP)		
	M20/EP12 mm	M24/EP15 mm	% increase	M20/EP12 mm	M24/EP15 mm	% increase
400 x 140 x 39.7 (12/4)	69	102	47.8%	103	160	55.3%
400 x 160 x 48.4 (14/4)	69	102	47.8%	103	160	55.3%
450 x 160 x 50.2 (14/4)	79	117	48.1%	120	187	55.8%
450 x 180 x 60.1 (16/4)	79	117	48.1%	120	187	55.8%
500 x 160 x 52.0 (14/4)	90	133	47.7%	137	214	56.2%
500 x 180 x 61.9 (16/4)	90	132	46.6%	137	214	56.2%
550 x 200 x 73.3 (16/5)	100	148	48.0%	155	241	55.5%
600 x 200 x 80.5 (16/6)	110	163	48.2%	173	268	54.9%

REFERENCES

- [1] Steel Construction Institute and British Constructional Steelwork Association, Joints in Steel Construction. Volume 1: Moment Connections, London: SCI & BCSA, 1995.
- [2] Eurocode 3, Design of Steel Structures: ENV 1993-1-1: Part 1.1: General Rules and Rules for Buildings, CEN, Brussels, 1992.
- [3] Md Tahir, M., Structural and Economic Aspects of The Use of Semi-Rigid Joints in Steel Frame, UK: University of Warwick, PhD Thesis, 1995.
- [4] G. H. Couchman, Design of Semi-continuous Braced Frames, UK: Steel Construction Institute, 1997.
- [5] Osman, M. H., "Performance Test and Research on Trapezoid Web Profile", Presentation in Design of Steel Structure Short Course, Malaysia: UTM, 2001.

- [6] Hussein, Wa' il Q. "*Design Guide for Steel Plate Girder with Corrugated Webs (TWP)*", Presentation in Design of Steel Structure Short Course, Malaysia: TWP Sdn Bhd, 2001.
- [7] Tan Cher Siang, *Buckling Analysis of Compression Member with Trapezoidal Web Profiled*, Malaysia: UTM M.Phil Thesis, 2004.
- [8] Steel Construction Institute and British Constructional Steelwork Association, *Joints in Simple Construction. Volume 1: Design Methods*, Second Edition, UK: SCI & BCSA, 1994.
- [9] Steel Construction Institute and British Constructional Steelwork Association, *Joints in Simple Construction. Volume 2: Practical Applications*, First Edition, UK: SCI & BCSA, 1992.
- [10] British Standards Institute, *BS 5950-1:2000 Structural Use of Steelwork in Building Part 1: Code of Practice for Design – Rolled and Welded Sections*, London: British Standards Institution, 2000.
- [11] Bose, B. *Tests to verify the performance of standard ductile connections*, Dundee Institute of Technology, 1993.
- [12] M. Md. Tahir, *Design of Semi-Continuous Construction for Multi-Storey Braced Steel Frames Using TWP sections*, Malaysia: Steel Technology Centre, UTM, 2003.
- [13] Abdalla, K. M. and Chen, W. F., "*Expanded Database of Semi-Rigid Steel Connections.*" *Computer And Structures*, Vol. 56, No. 4, pp 553-564, 1995.
- [14] Chen, W. F. et al. "*Semi-rigid Connections in Steel Frames*" Council on tall Buildings and Urban Habitat, Committee 43, New York: Mc Graw-Hill, 1993.
- [15] Chen, W. F. and Kishi, N., "*Semi-rigid Steel Beam-to-Column Connections: Database and Modelling.*" *Journal of Structural Engineering*, Vol. 115, No. 1, pp 105-119, 1989.
- [16] Jaspart, J. P., "*General Report: Session on Connections.*" *Journal of Constructional Steel Research*, Vol. 55, pp 69-89, 2000.
- [17] Luo, R., "*Load Carrying Capacity of Steel Girders and Panels with Thin-Walled Trapezoidally Corrugated Webs*" *Compilation of Papers*. Sweden: Chalmers University of Technology, 1995.

PROFILES



Assoc Prof Engr Dr Mohd Md Tahir
B.Sc (Civil Engineering) (Iowa, US), M.Eng (Structure)(Nebraska, US), PhD (Steel Structure)(Warwick, UK), P.Eng, MIEM. Fifteen-year experienced lecturer specialised in advanced steel structure of post-graduates programme, Universiti Teknologi Malaysia. Active in steel construction research, has conducted 12 research projects related to the invention of steel structures. Published over 50 papers at national and international stages, and has presented in seminars and conferences in Malaysia, Singapore, Italy, Greece, Korea, Indonesia and Thailand. He serves as advisor panellist for a number of bodies in Malaysia. He is currently Director of Steel Technology Centre at the Faculty of Civil Engineering.



Assoc Prof Dr Shahrin Mohammad
B.Eng (Hons) Civing Engineering (Liverpool), M.Phil (Structure)(Newcastle), PhD (Civil)(Sheffield). Join the academia at the Faculty of Civil Engineering (FKA), Universiti Teknologi Malaysia since 1984. He is currently the Director of Quality, UTM, fellow of Steel Technology Centre, Chairman of the ISO 9001:2000 Committee (FKA-UTM) and Chairman of the Corporate Affairs Committee (FKA-UTM). He is active in research work and in publication, and has presented in conferences in Malaysia, Singapore, Italy, Japan and Hungary. He has authored / edited several books: *Rekabentuk Konkrit Prategasan (DBS)*, *Rekabentuk Struktur keluli Menurut BS5950 (DBS)* and *Structural Fire Engineering - Investigation of the Gurun Test*.



Arizu Sulaiman
B.Sc (Hons) Civil Engineering (Missouri, USA), M.Eng (Structure)(UTM). Work as a lecturer at Faculty of Civil Engineering, Universiti Teknologi Malaysia. He is currently doing his PhD in Structural Engineering in UTM. Being active in research, his interest and area of expertise is analysis and design of steel structure.



Anis Saggaff
Got a bachelor degree in Civil Engineering at Sriwijaya University in 1987, obtained his Master of Civil Engineering at University of Kentucky USA in 1993, and He is now PhD candidate in Steel Composite Structure Field at Universiti Teknologi Malaysia. He has been a Lecturer and a Researcher at Sriwijaya University since 1987, and a vice head of Structure Laboratory at Sriwijaya University.